



**Switching Devices  
according to UL489, UL508 and UL1077**



**10kA IR**  
 Line 18-3 AWG  
 Load 18-2 AWG  
 Use Copper Wire Only 60/75C  
 Line/Load Reversible  
 Type UL: Frequency 50/60Hz  
 Type DL: Observe Polarity Markings

**Atttech Corp.** Phone (908) 806-9400, www.atttechcorp.com  
**UL489-Molded Case Circuit Breaker**  
 File E329510

**UL**  
 LISTED  
 ISSUE NO.

**1 pole**  
 min. 0.16 in (4 mm)

Made in Germany  
 9967430

**ABL SURSUM**  
**C16**  
 277V AC  
 1C16UL  
 HACR

**UL US**  
 LISTED  
 C.B.  
 10kA

1  
 2

**Atttech Corp.** Phone (908) 806-9400, www.atttechcorp.com  
**MANUAL MOTOR CONTROLLER Series V-EA**  
 Suitable for Motor Disconnect  
 - Suitable for the following loads:  
 - Rating listed on nameplate  
 - Amp

FLA*	STARTING/LRC	NOMINAL CIRCUIT VAC	1 PHASE / FLA & LRC CONVERTED TO TABLE HORSEPOWER
0.30A	1.80A	110-120	2001 2665 2777
1/2	1/2	1/2	1/2
1/3	1/3	1/3	1/3
1/4	1/4	1/4	1/4
1/6	1/6	1/6	1/6

Models rated up to 25A  
 42V dc, 30-60A 24V dc,  
 general purpose

**ABL SURSUM**  
**C10**  
 277V AC  
 1C10UM  
 240/415V AC  
 EN 80898

**UL**  
 LISTED  
 10kA  
 ACB7  
 DE

1  
 2

Made in Germany  
 590

## Editorial



**Dear Customers,  
Dear Business Partners,**

with this catalogue we invite you to explore the multi-faceted world of modern electrical installation in industry applications with the focus on the North American standards according to UL and CSA.

We are a traditional family-owned company and we look back with pride on more than 70 years of experience in developing and exporting products according to UL and CSA all around the world. We offer an extensive range of products according to UL489, UL508 and UL1077 for modern DIN-Rail installation. Combined with the wide range of accessories, we can offer our customers a flexible system to create state-of-the-art individual solutions.

Quality is the decisive factor for us. With proven materials, first-class workmanship and the highest quality standards, ABL SURSUM products are ideal for use in industry.

Only those who are open to change will be successful in the future. This guiding principle is what motivates us daily to make sure that we always use state-of-the-art technology, do not remain still, and continuously develop products innovatively for our customers with the most modern means available.

At ABL SURSUM, emotion is the enthusiasm for successful products. That is why we always work closely with our customers and can meet their specific requirements and offer individual solutions as quickly as possible. Our excellent service is always at your side, ready to provide support.

Sincerely

Dr. Stefan Schlutius  
CEO





## Your direct Line to us



**We see service as a top priority - and our customers realise and appreciate it!**

**Every order contains special requirements, requires competent advice, needs efficient, cost-effective solutions and, of course, must be fast.**

**Those are exactly the strengths of ABL SURSUM:**

- Open to the technical problems and individual requirements of our customers
- Proximity to customers and flexibility in working out individual solutions
- Advice and problem analysis with the excellent technical qualifications of our employees
- Fast offer and order processing
- High degree of vertical integration in-house
- Need-based warehouse storage – that means that for you as a customer: short delivery times for all standard products
- High degree of on-time delivery using a finely-meshed distribution network and modern logistics

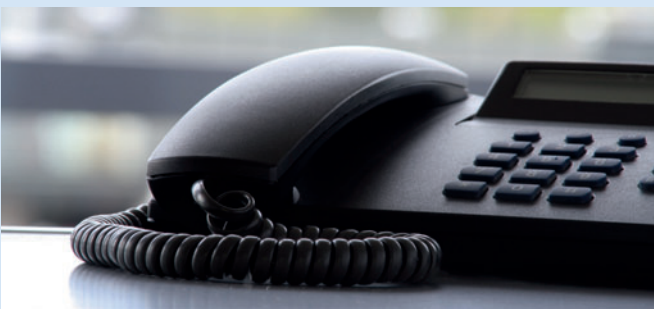

### **Sales Service Germany**

Telephone: +49 (0)9123/188-240, -182, -178, -135

### **Sales Service Abroad**

Telephone: +49 (0)9123/188-237, -197, -136, -116

### **Technical Service**

Telephone: +49 (0)9123/188-164, -126, -148

**Fax: +49 (0)9123/188-188, -189**

**E-mail: [info@abl-sursum.com](mailto:info@abl-sursum.com)**

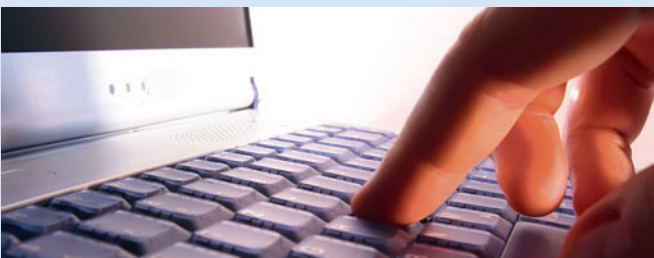

**Detailed information can be found at:  
[www.abl-sursum.com](http://www.abl-sursum.com)**



---

## Table of Contents

<b>Editorial</b>	Page	02
<b>ABL SURSUM – the company</b>	Page	06
<b>Our representatives worldwide</b>	Page	10
<b>Switching devices from ABL SURSUM have a lot to commend them</b>	Page	12
<b>Switching devices acc. to UL489 and CSA-22.2 no. 5-09</b>		
- Product advantages	Page	18
- UL Product Range, AC version C and D characteristics	Page	20
- UL Product Range, DC version C characteristic	Page	22
- Accessories	Page	23
- Busbars	Page	25
- Technical data	Page	26
<b>Switching devices acc. to UL508 and CSA-22.2 no. 14</b>		
- Product advantages	Page	32
- UM Product Range B, C, D, G, E, Z characteristics	Page	35
- Accessories	Page	38
- Busbars	Page	40
- Technical data	Page	42
<b>Manual Motor Controller MA acc. to UL508 and CSA-22.2 no. 14</b>		
- Product advantages	Page	50
- Product range MA...UM	Page	53
- Accessories	Page	54
- Technical data	Page	56
<b>Manual Motor Controller MS</b>		
- Product advantages	Page	60
- Manual Motor Controller MS	Page	61
- Accessories	Page	62
- Technical data	Page	66
<b>Switching devices acc. to UL1077 and CSA-22.2 no. 235</b>		
- Product advantages	Page	70
- UR Product Range B, C, D characteristics	Page	72
- Accessories	Page	74
- Technical data	Page	76
<b>ABL SURSUM – the product range</b>	Page	80
<b>Article number directory</b>	Page	86

## From Conception to Delivery

We are oriented towards the requirements of the national and international markets and the desires of our customers which we approach passionately with a wealth of ideas, engineering skills and the power of innovation.



**Location:**  
**Innovative products from Lauf**

With a wide range of more than 7,000 products, the traditional German company ABL SURSUM delivers to markets all around the world.



**Development:  
Everything in-house**

Every new product begins with an idea. In order to implement it, a lot of experience and the right tools are needed. That is why development at ABL SURSUM is not only carried out with the most modern CAD software available, but also in constant dialogue with customers. Because it is only with exact knowledge of products and markets that one can create innovative, need-based products.

**Tool and equipment manufacture:  
Focus on quality**

The quality of a production starts with the right production facilities. That is why ABL SURSUM builds and maintains its own custom plastic and metal machining tools. At the same time, a large proportion of the machines and equipment are constructed in our own equipment manufacturing facilities. Because if you plan and build something yourself, you can maintain it optimally, adjust it to meet new challenges and constantly develop it further.

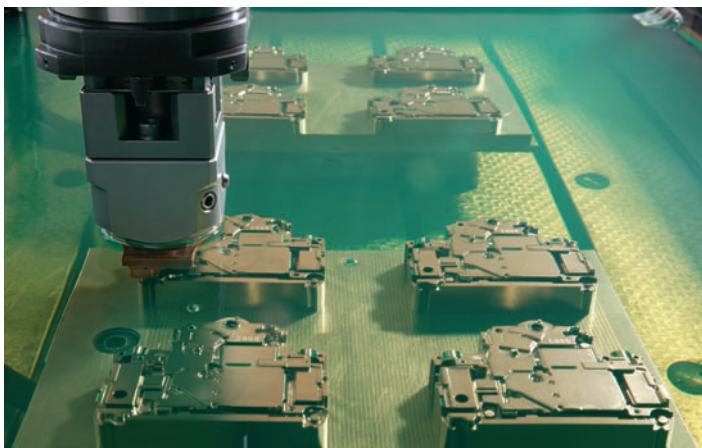





**Vertical integration:  
Greatest perfection down to the smallest detail**

Even the smallest detail can be decisive in determining the perfection of the whole. The extensive vertical integration of ABL SURSUM guarantees the highest quality and dimensional accuracy over a product's entire life cycle. An Acquisition Management perfectly harmonised with Production allows materials to be available on time without interruption of work flow.

**Final assembly:  
Combining know-how and technology**

Experienced, qualified employees and a high level of automation enable on-time production, while maintaining a consistently high level of quality. Because only high-quality products are convincing in the long term.







Quality control:  
No compromises

Permanent quality monitoring with the assistance of the most up-to-date inspection procedures is a matter of course at ABL SURSUM. That is why there are no compromises when it comes to monitoring ongoing production and the final inspections.  
ABL SURSUM is also certified according to DIN ISO 9001.

**Logistics:  
Service begins with delivery**

In this day and age of tighter and tighter schedules, a well-organised distribution network and modern logistics ensure on-time delivery to both domestic and foreign markets. This ensures that ABL SURSUM with an export rate of over 50%, can deliver daily on-time to numerous customers all over the world.

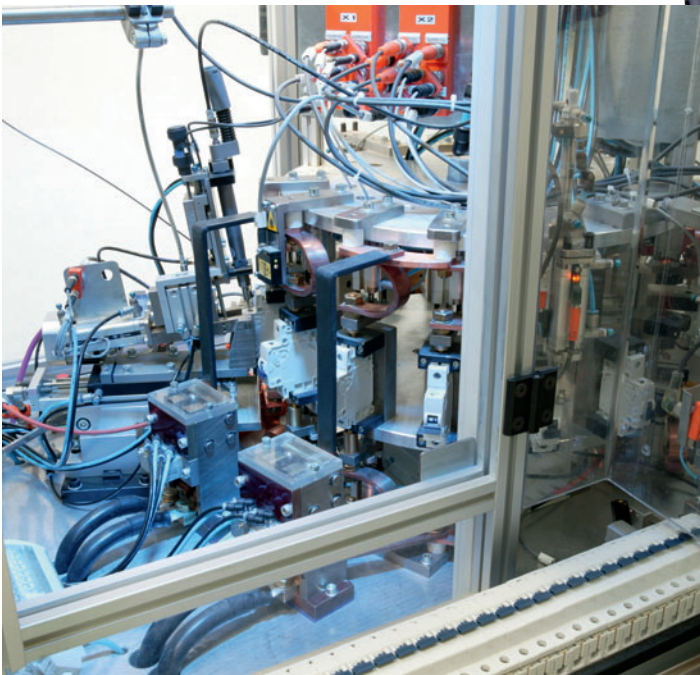
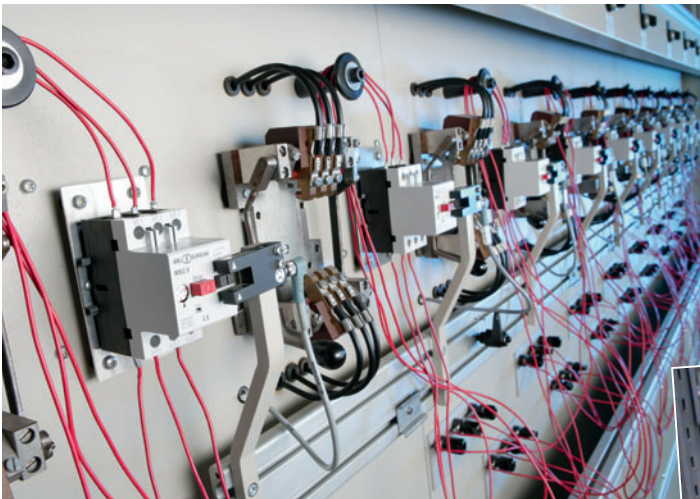

**We are available for you –  
wherever you are**

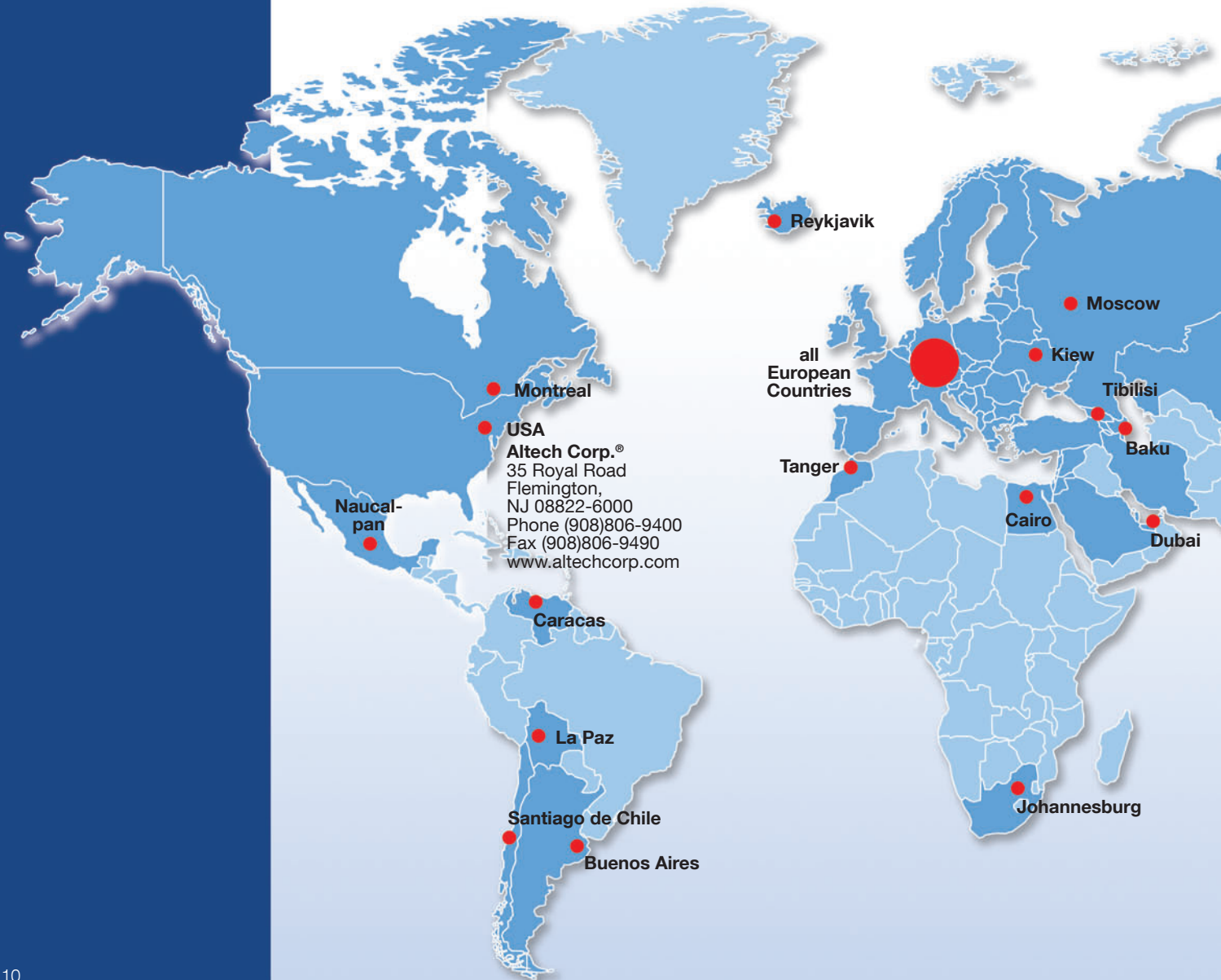

**Altech Corp.®**  
35 Royal Road  
Flemington,  
NJ 08822-6000  
Phone (908)806-9400  
Fax (908)806-9490  
[www.altechcorp.com](http://www.altechcorp.com)





### Representatives throughout Europe:

Belgium	Netherlands
Denmark	Norway
Estonia	Austria
Finland	Poland
France	Portugal
Greece	Romania
Great Britain	Sweden
Ireland	Switzerland
Italy	Slovakia
Latvia	Spain
Lithuania	Czech Republic
Luxemburg	Hungary



### International representatives:

Egypt	Mexico
Argentina	New Zealand
Azerbaijan	Russia
Bolivia	Singapore
Bosnia Herzegovina	South Africa
Chile	Taiwan
China	Thailand
Georgia	Ukraine
India	USA
Iceland	Venezuela
Canada	United Arab Emirates
Croatia	Vietnam
Morocco	Belarus

**1 Functional form**

- Modern design
- User-friendly ergonomics
- Easy-to understand product designation
- Clearly legible ON/OFF labelling

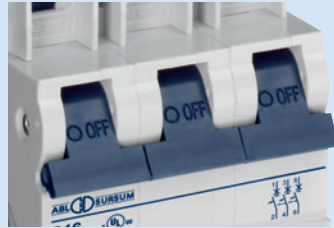

**3 UL Circuit breakers in an uniform and modern design**

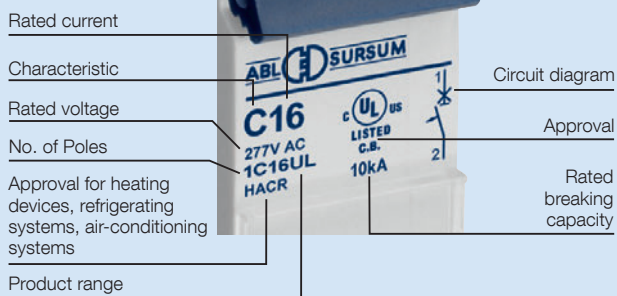

**2 Compact design offering maximum wiring space**

- With 105 mm installation height one of the smallest circuit breakers according to UL489
- With 89,3 mm the smallest UL508 manual motor controller
- The same small dimensions of 89,3 mm for UL1077 supplementary protector

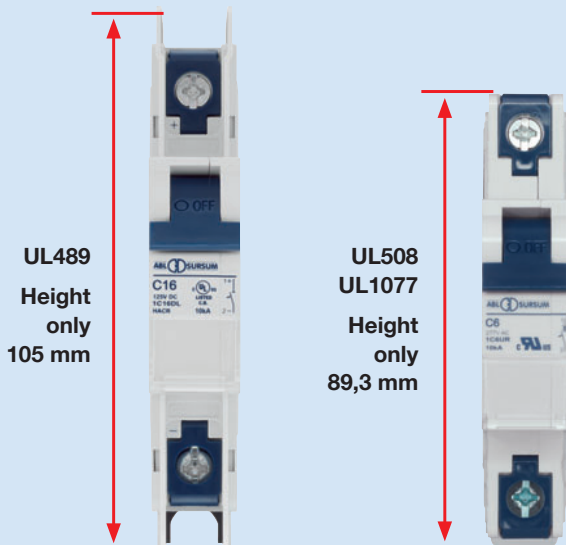

**4 Extensive application possibilities**

- Three product ranges for circuit protection, manual motor controlling and supplementary protection applications
- AC and DC versions available
- European and North American standard tripping characteristics with the widest range of nominal ratings
- **UL489**  
AC, 0.3 - 63 A, 1-pole/2-pole/3-pole  
UL product range characteristics AC: B, C, D, Z  
DC, 0.3 - 63 A, 1-pole/2-pole  
DL product range characteristic C
- **UL508**  
0.3 - 63 A, 1-pole/2-pole/3-pole acc. to UL508 and CSA-22.2 No.14  
UM product range, B, C, D,G, E and Z characteristic  
B, C and D up to 25 A also acc. to IEC 60898-1, DIN EN 60898-1, VDE 0641-11
- **UL1077**  
0.5 - 63 A, 1-pole/2-pole/3-pole acc. to UL1077 and CSA-22.2 No.235  
UR product range characteristic B, C, and D

# Switching Devices from ABL SURSUM have a lot to commend them

## 5 Complete Product System

- Full range of accessories for UL489 Circuit breakers
- Common line of accessories for UL508 and UL1077 Product lines
- Full range of auxiliary switches
- Shunt trip and neutral pole can be added on the left and the right side

  
**LISTED**  
**C.B. ACC.**  
**3NY7**  
 File E 335632

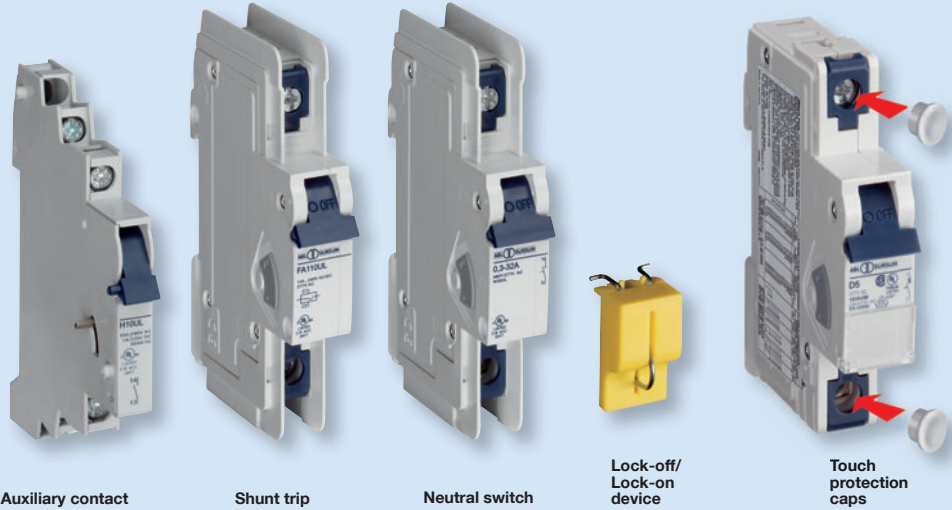

## 6 Professional labeling System with a marking window

Blank perforated labels available for one pole, two pole and three pole windows for convenient circuit indication



## 7 Standard dual connection method for all three product ranges

- Box clamp terminal (line load reversible)
- for solid and flexible conductors  
 Top: 18-3AWG (1,0 mm<sup>2</sup> - 25 mm<sup>2</sup>)  
 Bottom: 18-2AWG (1,0 mm<sup>2</sup> - 35 mm<sup>2</sup>)
- for busbars

Unique way of connecting for convenient connection of all types of cable lugs (ring tongue and fork cable lugs)

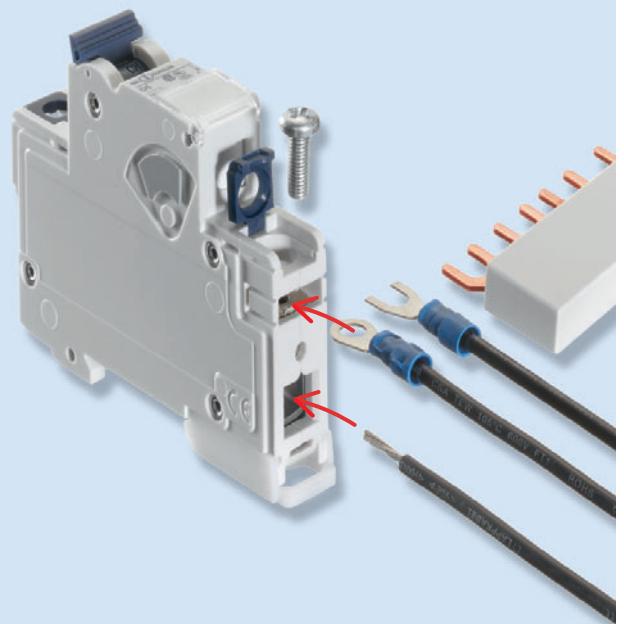



### Busbars available for UL489 device

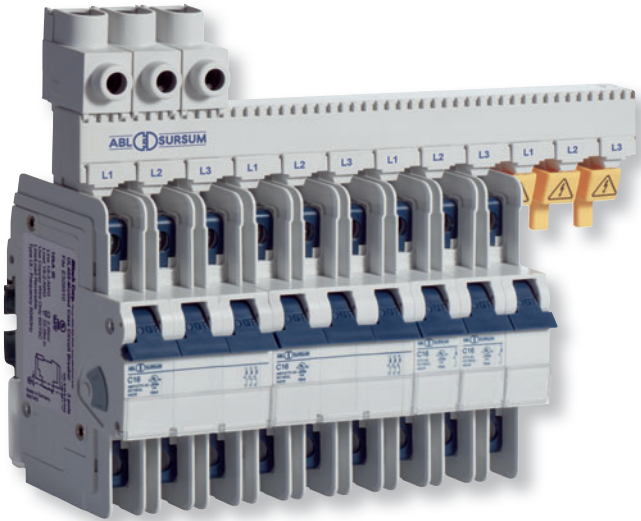

### Busbars available for UL508 and UL1077 device

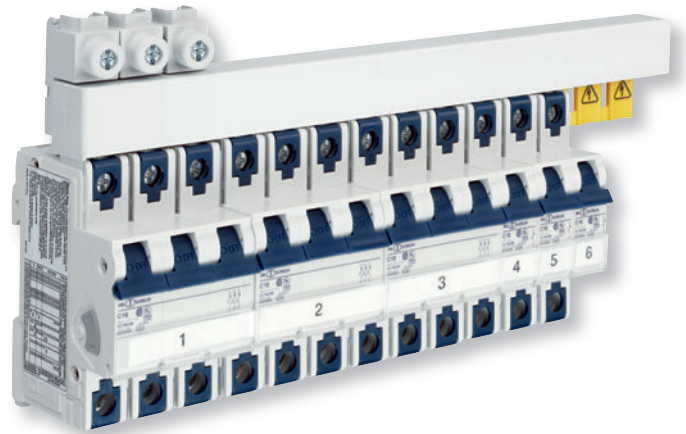

### Extensive application possibilities

- Extensive application possibilities
- Three product ranges for circuit protection, manual motor controlling and supplementary protection applications
- AC and DC versions available
- European and North American standard tripping characteristics with the widest range of nominal ratings

Product Range	UL			DL		UM **						UR **	
Standards	UL489					UL508						UL1077	
UL File	E 329510					E 137938						E 137915	
Rated voltage	240 V AC	277 V AC	480 V AC	125 V DC	250 V DC	277 V AC	480 V AC	42 V DC	80 V DC	24 V DC	60 V DC	277 V AC	480 V AC
Number of poles	1 / 1+N* / 2 / 3 / 3+N*	1 / 1+N*	2 / 3 / 3+N*	1	2	1 / 1+N*	2 / 3 / 3+N*	1	2	1	2	1 / 1+N*	2 / 3 / 3+N*
B - Characteristic						1-63 A	1-63 A	1-25 A	1-25 A	30-63 A	30-63 A	1-63 A	1-63 A
C - Characteristic	40-63 A	0.3-32 A	0.3-32 A	0.3-63 A	0.3-63 A	0.3-63 A	0.3-63 A	0.3-25 A	0.3-25 A	30-63 A	30-63 A	0.3-63 A	0.3-63 A
D - Characteristic	40-63 A	0.3-32 A	0.3-32 A			0.3-63 A	0.3-63 A	0.3-25 A	0.3-25 A	30-63 A	30-63 A	0.3-63 A	0.3-63 A
E - Characteristic						0.3-63 A	0.3-63 A	0.3-25 A	0.3-25 A	30-63 A	30-63 A		
G - Characteristic						0.3-63 A	0.3-63 A	0.3-25 A	0.3-25 A	30-63 A	30-63 A		
Z - Characteristic						0.3-50 A	0.3-50 A	0.3-25 A	0.3-25 A	30-50 A	30-50 A		

\* N pole to be mounted separately

\*\* UL approval up to 60 A

**Full range of accessories for UL489 , UL508 and UL1077**

- Auxiliary switches
- Shunt trip and Neutral pole can be added on the left and the right side

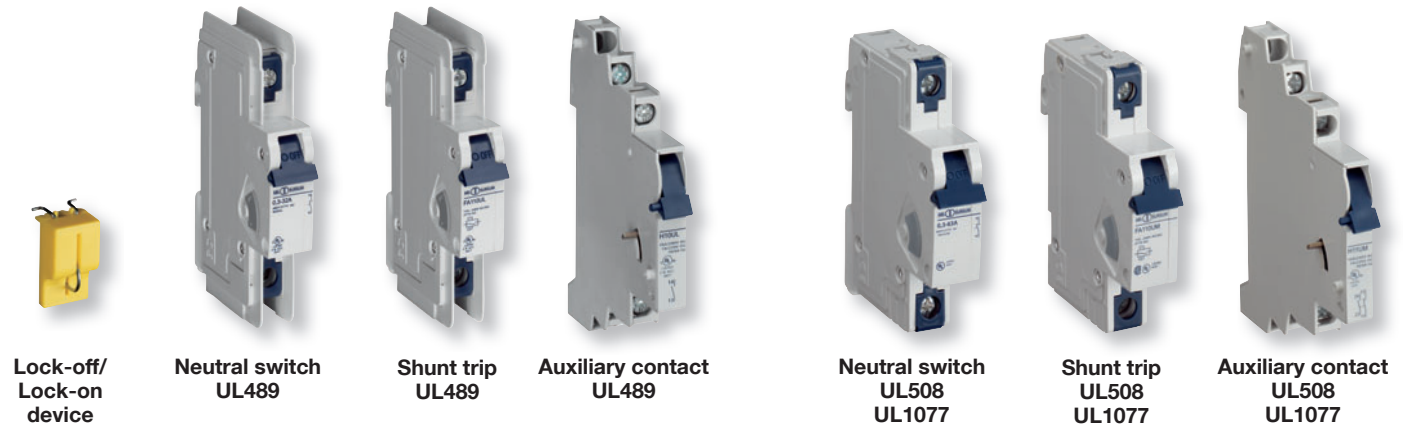

	UL489 Listed Circuit Breakers AC Distribution Equipment	UL508 Listed Manual Motor Controller Industrial Control Equipment	UL1077 Supplementary Protector
<b>Main Characteristics</b>			
Listed component	●	●	
Recognized components for supplementary protection only			●
Field wiring	●	●	
Factory wiring	●	●	●
Feeder circuit protection	●		
Branch circuit protection	●		
Control Circuits	●	●	●
<b>Functions</b>			
Short circuit protection	●		
Switching function	●	●	
Disconnect function	●	●	
Overload protection	●	●	●
<b>Applications</b>			
Heaters, cooler, -air conditioning (HACR approval)	●		
Protection of outlets	●		
Transformers	●		
Motor protection	●	●	
Control transformers	●	●	●
Resistive load	●	●	●
Appliances, Business Equipment	●	●	●
General lamps	●	●	●
Fuorescent lamps	●	●	●

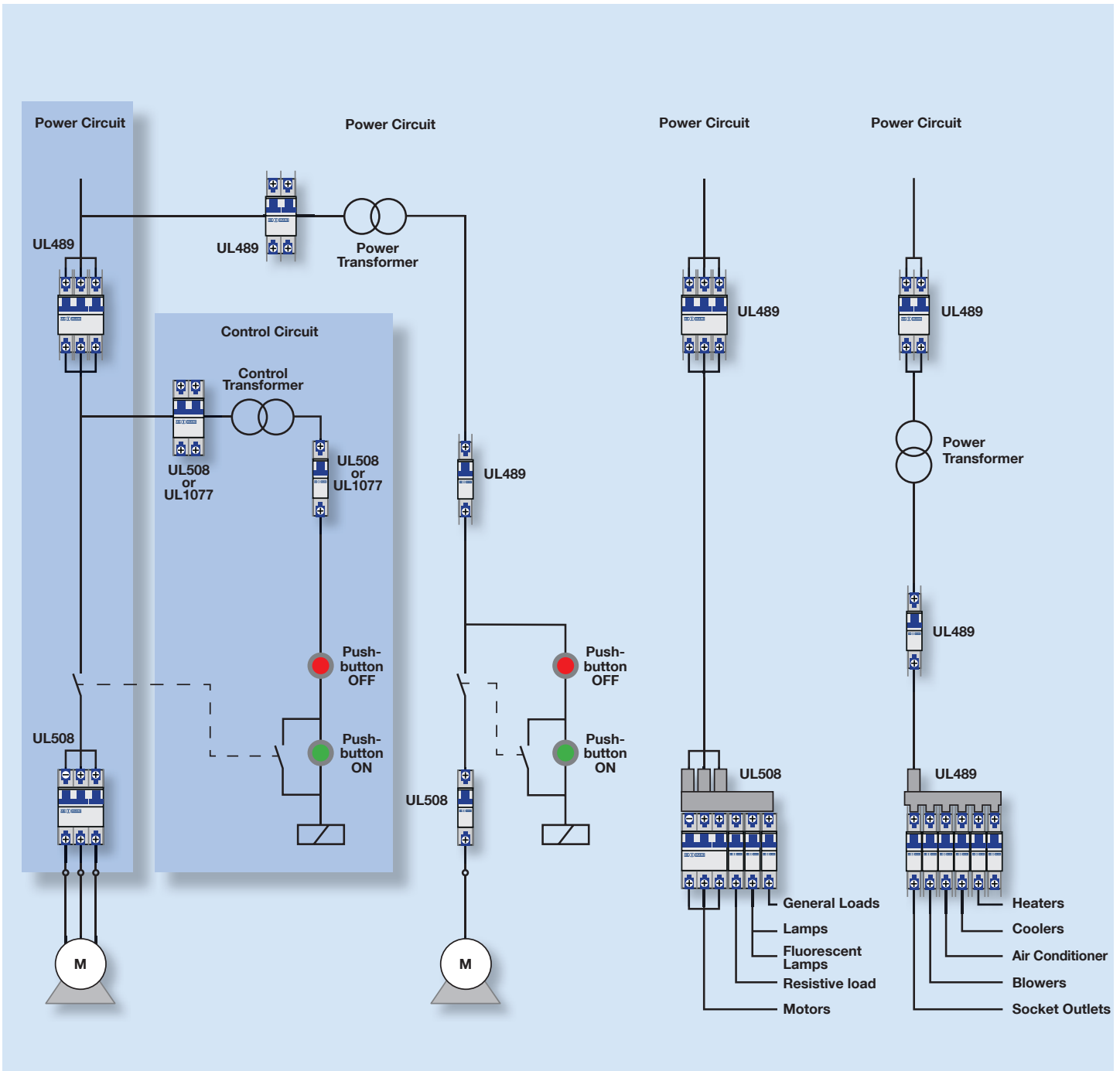

**Sizing of main branch circuit protector according to table 430.52 in NEC®**

• **Dual Element (Time Delay) Fuse**

Maximum fuse = largest motor FLA x 175 %  
 + FLA of all other motors and general loads in group

• **Inverse Time Breaker**

Maximum circuit breaker = largest motor FLA x 250 %  
 + FLA of all other motors and general loads in group  
 (for other fuse/breaker types see table 430.52)



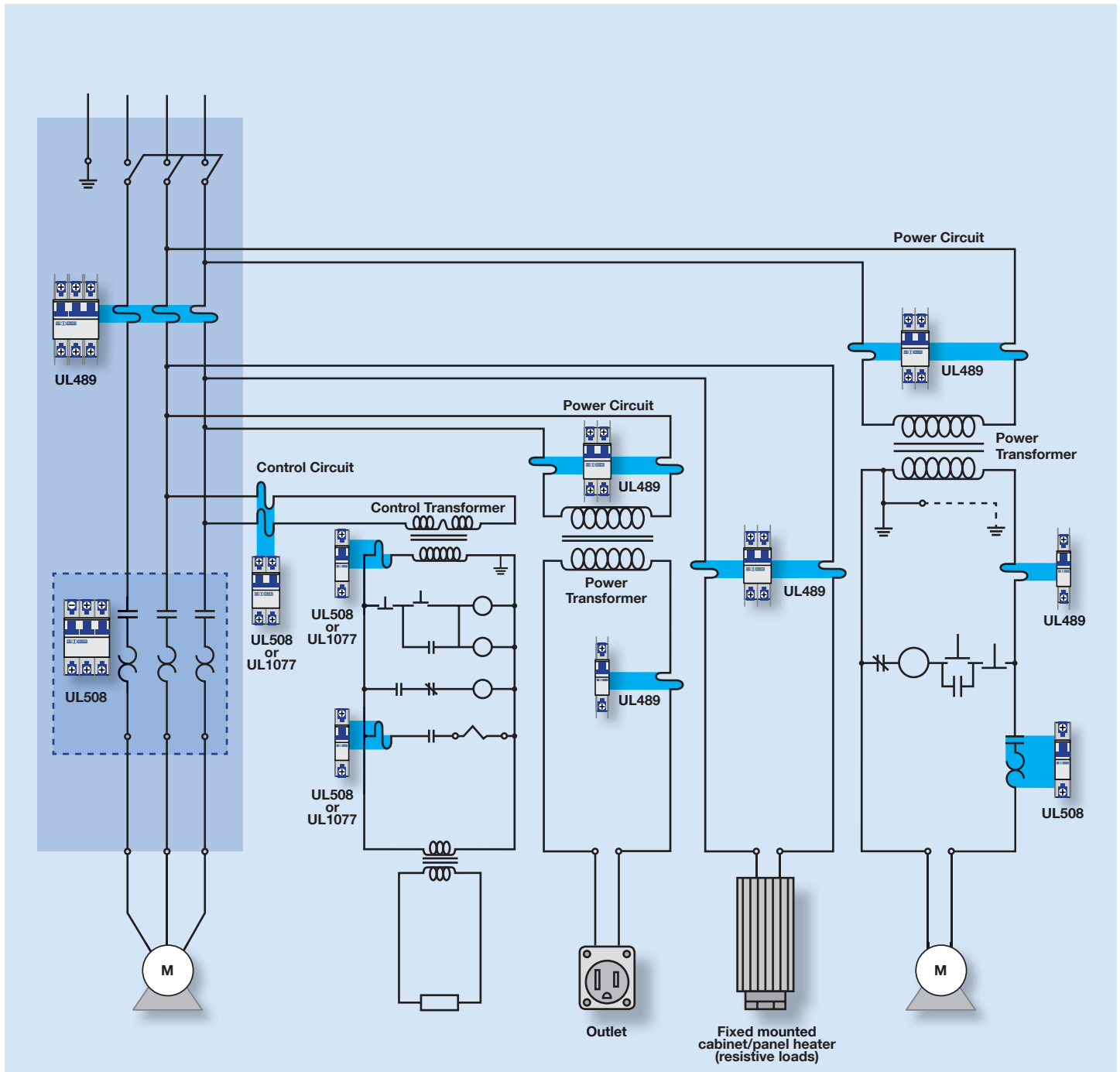

**Sizing of main branch circuit protector according to table 430.52 in NEC®**

• **Dual Element (Time Delay) Fuse**

Maximum fuse = largest motor FLA x 175 %  
+ FLA of all other motors and general loads in group

• **Inverse Time Breaker**

Maximum circuit breaker = largest motor FLA x 250 %  
+ FLA of all other motors and general loads in group  
(for other fuse/breaker types see table 430.52)

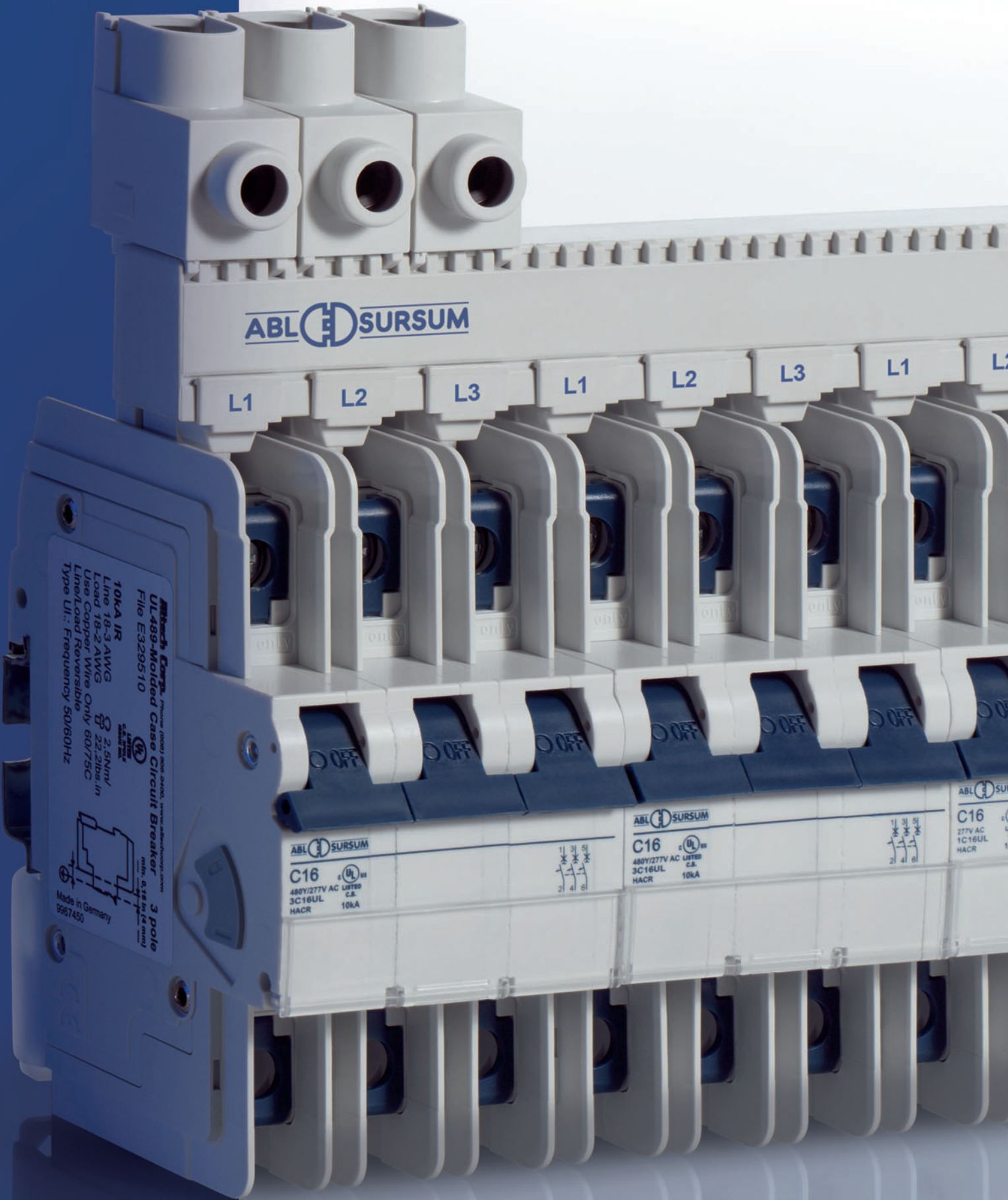

**Attach Comp. (2003) 1000, 10000, 100000, 1000000, 10000000, 100000000, 1000000000**  
**UL489-Molded Case Circuit Breaker**  
**File E329510**  
**10kA IR**  
**Line 18-3 AWG**  
**Load 18-3 AWG**  
**Lead 18-3 AWG**  
**Line/Load Reversible**  
**Type UI: Frequency 50/60Hz**  
**3 pole**  
**30mm (1.18 in.)**  
**9967450**  
**Made in Germany**

**ABL SURSUM**  
**C16**  
**480V/277V AC LISTED**  
**3C16UL**  
**HACR**  
**10kA**

**ABL SURSUM**  
**C16**  
**480V/277V AC LISTED**  
**3C16UL**  
**HACR**  
**10kA**

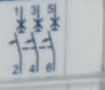

**ABL SURSUM**  
**C16**  
**277V AC**  
**1C16UL**  
**HACR**

---

## Switching Devices according to UL489 and CSA-22.2 No. 5-09



Listed circuit breakers according to UL489 and CSA-22.2 No.5-09 help with the complex selection of the correct type and characteristics compared to traditional fuse installation, and offer a less space-consuming installation solution. Our range of miniature moulded case circuit breakers combined with our factory or field mounted accessories offer enhanced control and monitoring capabilities. Field mounting kits include all parts and instructions to ensure easy installation on site.

We supply 1, 2 and 3-pole-type switching devices according to UL489 from 0.3 to 63 Ampere and with C and D characteristics. Furthermore, attachments such as neutral switches, auxiliary contacts and shunt trips are available for this system. All accessories for modern busbar installations are available in accordance with the relevant UL standards.

# Switching Devices Listed Circuit Breakers AC

according to UL489 and CSA-22.2 No. 5-09  
UL Product Range, AC Version, C and D Characteristics



File E 329510



Rated current I <sub>n</sub> A	Rated voltage Volt AC	Characteristic *		Weight g/each	Packing unit
		C Article no.	D Article no.		

1-pole					
0.3	277/480	1C03UL	1D03UL	155	12
0.5	277/480	1C05UL	1D05UL	155	12
1	277/480	1C1UL	1D1UI	155	12
1.6	277/480	1C1.6UL	1D1.6UL	155	12
2	277/480	1C2UL	1D2UL	155	12
3	277/480	1C3UL	1D3UL	155	12
4	277/480	1C4UL	1D4UL	155	12
5	277/480	1C5UL	1D5UL	155	12
6	277/480	1C6UL	1D6UL	155	12
8	277/480	1C8UL	1D8UL	155	12
10	277/480	1C10UL	1D10UL	155	12
12	277/480	1C12UL	1D12UL	155	12
13	277/480	1C13UL	1D13UL	155	12
15	277/480	1C15UL	1D15UL	155	12
16	277/480	1C16UL	1D16UL	155	12
20	277/480	1C20UL	1D20UL	155	12
25	277/480	1C25UL	1D25UL	155	12
30	277/480	1C30UL	1D30UL	155	12
32	277/480	1C32UL	1D32UL	155	12
40	240	1C40UL	1D40UL	155	12
50	240	1C50UL	1D50UL	155	12
60	240	1C60UL	1D60UL	155	12
63	240	1C63UL	1D63UL	155	12

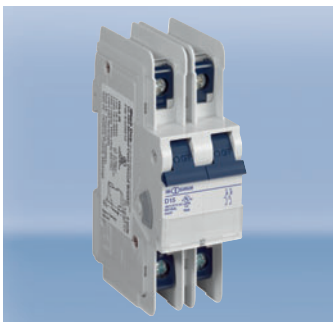

2-pole					
0.3	277/480	2C03UL	2D03UL	310	6
0.5	277/480	2C05UL	2D05UL	310	6
1	277/480	2C1UL	2D1UI	310	6
1.6	277/480	2C1.6UL	2D1.6UL	310	6
2	277/480	2C2UL	2D2UL	310	6
3	277/480	2C3UL	2D3UL	310	6
4	277/480	2C4UL	2D4UL	310	6
5	277/480	2C5UL	2D5UL	310	6
6	277/480	2C6UL	2D6UL	310	6
8	277/480	2C8UL	2D8UL	310	6
10	277/480	2C10UL	2D10UL	310	6
12	277/480	2C12UL	2D12UL	310	6
13	277/480	2C13UL	2D13UL	310	6
15	277/480	2C15UL	2D15UL	310	6
16	277/480	2C16UL	2D16UL	310	6
20	277/480	2C20UL	2D20UL	310	6
25	277/480	2C25UL	2D25UL	310	6
30	277/480	2C30UL	2D30UL	310	6
32	277/480	2C32UL	2D32UL	310	6
40	240	2C40UL	2D40UL	310	6
50	240	2C50UL	2D50UL	310	6
60	240	2C60UL	2D60UL	310	6
63	240	2C63UL	2D63UL	310	6

\* Also available in B and Z characteristics on request



# Switching Devices Listed Circuit Breakers AC

according to UL489 and CSA-22.2 No. 5-09  
UL Product Range, AC Version, C and D Characteristics



File E 329510



Rated current $I_n$ A	Rated voltage Volt AC	Characteristic *		Weight g/each	Packing unit
		C Article no.	D Article no.		

3-pole					
0.3	277/480	3C03UL	3D03UL	415	4
0.5	277/480	3C05UL	3D05UL	415	4
1	277/480	3C1UL	3D1UI	415	4
1.6	277/480	3C1.6UL	3D1.6UL	415	4
2	277/480	3C2UL	3D2UL	415	4
3	277/480	3C3UL	3D3UL	415	4
4	277/480	3C4UL	3D4UL	415	4
5	277/480	3C5UL	3D5UL	415	4
6	277/480	3C6UL	3D6UL	415	4
8	277/480	3C8UL	3D8UL	415	4
10	277/480	3C10UL	3D10UL	415	4
12	277/480	3C12UL	3D12UL	415	4
13	277/480	3C13UL	3D13UL	415	4
15	277/480	3C15UL	3D15UL	415	4
16	277/480	3C16UL	3D16UL	415	4
20	277/480	3C20UL	3D20UL	415	4
25	277/480	3C25UL	3D25UL	415	4
30	277/480	3C30UL	3D30UL	415	4
32	277/480	3C32UL	3D32UL	415	4
40	240	3C40UL	3D40UL	415	4
50	240	3C50UL	3D50UL	415	4
60	240	3C60UL	3D60UL	415	4
63	240	3C63UL	3D63UL	415	4

\* Also available in B and Z characteristics on request



File E 335632

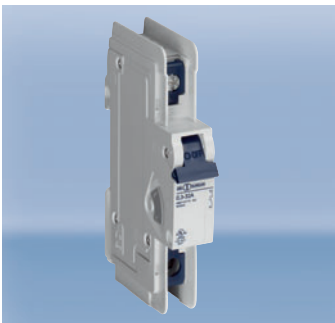

Rated current $I_n$ A	Rated voltage Volt AC	Test currents * electromagnetic		Article no.	Weight g/each	Packing unit
		not tripping $I_4$ A	tripping $I_5$ A			

Neutral switch – for mounting instructions please consult page 9						
0.3 - 32	277/480	400	700	N32UL	165	6
40 - 63	240	630	1000	N63UL	165	6

\* additional electromagnetic protection

# Switching Devices Listed Circuit Breakers DC

according to UL489 and CSA-22.2 No. 5-09  
DL Product Range, DC Version, C Characteristic



File E 329510

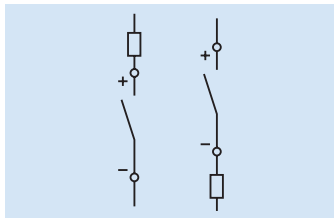
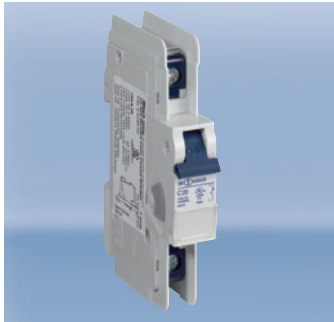

Rated current I <sub>n</sub> A	Rated voltage Volt DC	Characteristic C Article no.	Weight g/each	Packing unit
-----------------------------------	--------------------------	------------------------------------	------------------	-----------------

1-pole				
0.3	125	1C03DL	165	12
0.5	125	1C05DL	165	12
1	125	1C1DL	165	12
1.6	125	1C1.6DL	165	12
2	125	1C2DL	165	12
3	125	1C3DL	165	12
4	125	1C4DL	165	12
5	125	1C5DL	165	12
6	125	1C6DL	165	12
8	125	1C8DL	165	12
10	125	1C10DL	165	12
12	125	1C12DL	165	12
13	125	1C13DL	165	12
15	125	1C15DL	165	12
16	125	1C16DL	165	12
20	125	1C20DL	165	12
25	125	1C25DL	165	12
30	125	1C30DL	165	12
32	125	1C32DL	165	12
40	125	1C40DL	165	12
50	125	1C50DL	165	12
60	125	1C60DL	165	12
63	125	1C63DL	165	12

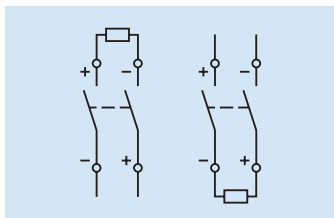
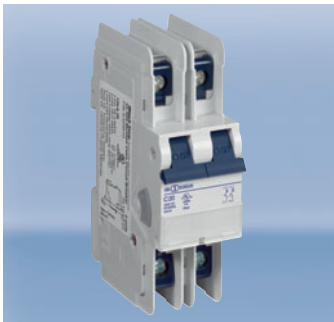

2-pole				
0.3	250	2C03DL	330	6
0.5	250	2C05DL	330	6
1	250	2C1DL	330	6
1.6	250	2C1.6DL	330	6
2	250	2C2DL	330	6
3	250	2C3DL	330	6
4	250	2C4DL	330	6
5	250	2C5DL	330	6
6	250	2C6DL	330	6
8	250	2C8DL	330	6
10	250	2C10DL	330	6
12	250	2C12DL	330	6
13	250	2C13DL	330	6
15	250	2C15DL	330	6
16	250	2C16DL	330	6
20	250	2C20DL	330	6
25	250	2C25DL	330	6
30	250	2C30DL	330	6
32	250	2C32DL	330	6
40	250	2C40DL	330	6
50	250	2C50DL	330	6
60	250	2C60DL	330	6
63	250	2C63DL	330	6



**Correct polarity must be ensured when connecting the DC switching devices!**

## Mounting Instructions of Accessories

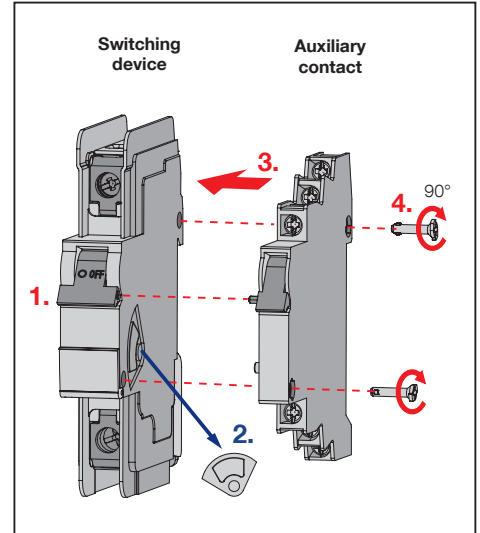
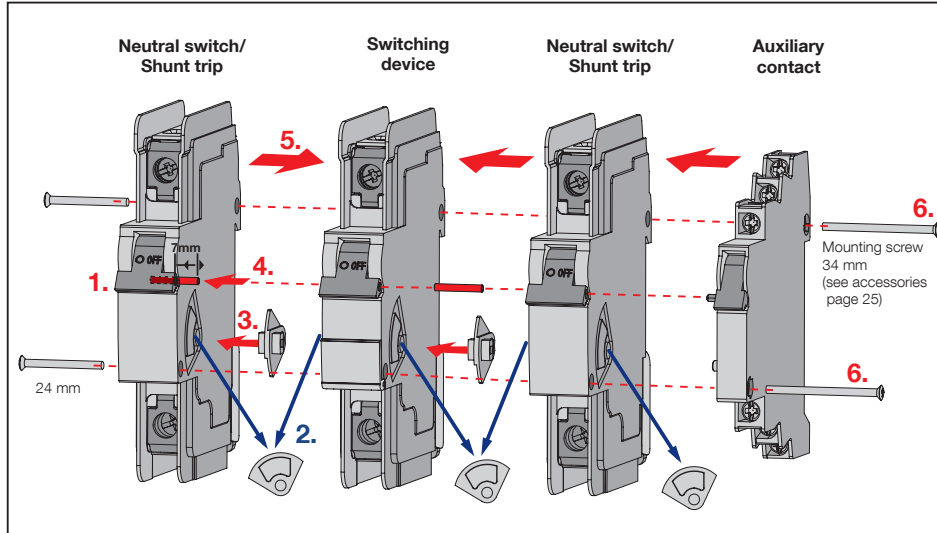

**Applies to N...UL and FA...UL:**  
The accessory devices N...UL and FA...UL can be mounted **on the right or left**.  
The auxiliary contact H...UL can only be mounted **on the right**.

**Mounting:**  
1. Bring the blue knobs of all devices into the "OFF" position  
2. Remove grey cover from the switching device and attachment  
3. Insert drive plate between the switching device and N...UL or FA...UL  
4. Insert connecting pin into the knob (insertion depth approx. 7 mm)  
5. Combine switching device and N...UL or FA...UL  
6. Screw devices together (observe correct screw length)

**Applies to H...UL:**  
The auxiliary contact H...UL can only be mounted **on the right**.

**Mounting:**  
1. Bring the blue knobs of both devices into the "OFF" position  
2. Remove grey cover from the switching device  
3. Combine switching device and H...UL  
4. Insert connection screws and connect the two devices by turning the screws by 90°  
5. After mounting close and open to check operation

### Applies to all switching devices ...UL, ...DL, N32UL, N63UL and FA...UL:

The load and mains can be connected either from the top or the bottom (Line/Load Reversible).



Box terminal for  
• solid conductors  
• flexible conductors with or without cable lug



Screw terminal for forked cable lug



Screw terminal for ring cable lug (ring tongue)

### Design of the terminals

- Optical detection of the screw position
- Increased break resistance if the screwdriver becomes jammed
- Universal connecting terminals, suitable for connecting all known cable lugs such as ring or forked cable lugs and pin terminals
- Ring cable lugs can be connected by opening the flap and removing the connecting screw
- Can also be used for applications that require ring cable lugs (e.g. nuclear power stations)
- Protection against contact with live parts according to DIN EN 50274, VDE 0660-514 is fully guaranteed

# Accessories for Switching Devices Listed Circuit Breakers

according to UL489 and CSA-22.2 No. 5-09  
for Product Ranges UL and DL



### Auxiliary contact, for mounting on the right

Module	Type of contact	Contacts	Article no.	Weight g/each	Packing unit
1/2	1 auxiliary contact	1NO	<b>H10UL</b>	35	6
1/2	2 auxiliary contacts	1NO + 1NC	<b>H11UL</b>	40	6
1/2	3 auxiliary contacts	1NO + 2NC	<b>H12UL</b>	45	6
1/2	3 auxiliary contacts	2NO + 1NC	<b>H21UL</b>	45	6

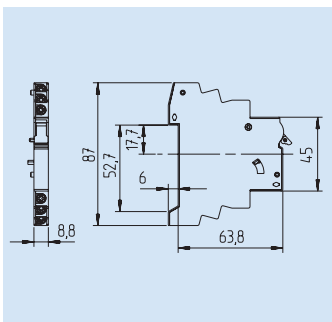

Standards	UL489 and CSA-22.2 Nr. 5-09	
Rated operating currents	10 A / 240 V AC 3 A / 110 V DC 1 A / 220 V DC	
Minimum contact load	1 mA at 24 V DC	
Conductor cross sections		
Type of conductor *)	min.	max.
Single wire	1.0 mm <sup>2</sup> (AWG18)	2.5 mm <sup>2</sup> (AWG14)
Stranded wire	1.0 mm <sup>2</sup> (AWG18)	1.5 mm <sup>2</sup> (AWG16)
Stranded wire with ferrule	1.0 mm <sup>2</sup> (AWG18)	1.5 mm <sup>2</sup> (AWG16)
Torque	max. 0.8 Nm (7 lb.in)	

\*) Stripped length 8 - 9 mm

( ) values in brackets = measurement units for North America



### Shunt trip, for mounting on the right or left

Module	Rated operating voltage	max. operating current at U <sub>n</sub> (t < 10 ms)	Article no.	Weight g/each	Packing unit
1	12 V UC	1.3 A	<b>FA12UL</b>	110	5
1	24 V UC	0.6 A	<b>FA24UL</b>	110	5
1	48 - 72 V UC	0.2 A	<b>FA48UL</b>	110	5
1	110 - 240 V UC, 277 V AC	0.25 A at 110 V 0.5 A at 240 V 0.58 A at 277 V	<b>FA110UL</b>	110	5



Lock-off/Lock-on device		
Article no.	Weight g/each	Packing unit
<b>EASS</b>	2	10

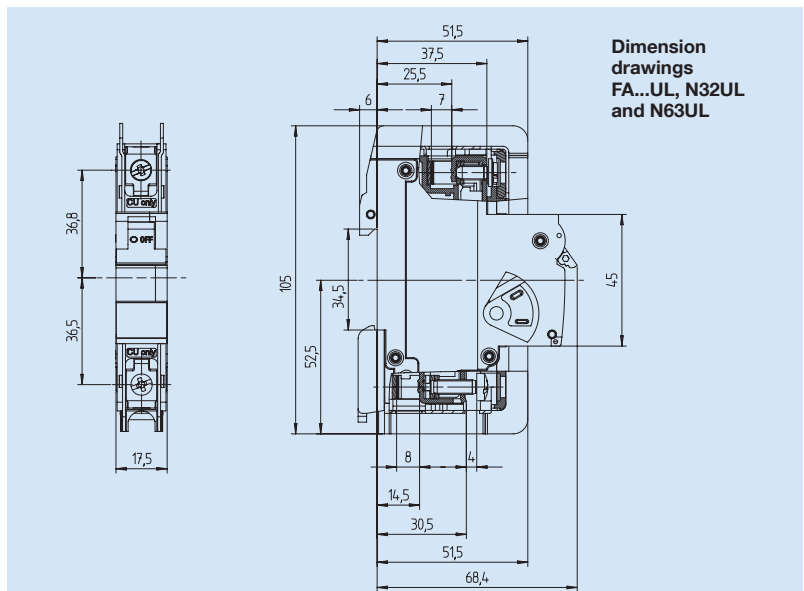



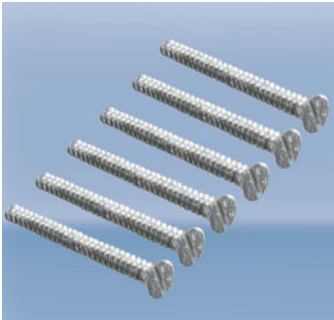

### Mounting screw 34 mm

to connect the auxiliary contact and shunt trip or neutral switch to the switching devices

Packing unit: 10 pieces  
**Article no. E983419**



### Touch-protection caps

to cover the connecting screws on the switching devices, neutral switches and shunt trips for increased touch protection

Packing unit: 100 pieces  
**Article no. BS.UL**

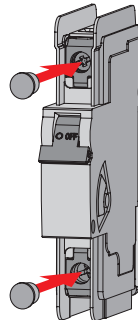

## Busbars pin type

Cross section [mm <sup>2</sup> ]	Busbar current	Number of poles	Article no.	Weight g/each	Packing unit
<b>1-phase</b>					
16	115	6	<b>S106U</b>	58	1
16	115	12	<b>S112U</b>	115	1
<b>2-phase</b>					
16	115	6	<b>S206U</b>	67	1
16	115	12	<b>S216U</b>	132	1
<b>3-phase</b>					
16	115	6	<b>S306U</b>	72	1
16	115	12	<b>S316U</b>	140	1

## Power feed terminals

6 - 35	115		<b>AK35U</b>	33	3
--------	-----	--	--------------	----	---

## Protection cover for busbars

			<b>S3BRU</b>	5	5
--	--	--	--------------	---	---



**Busbars cannot be cut to length!**

Characteristic *		C	D
Application		Lighting Wiring protection Control circuits Business equipment Appliances Motors low inrush	Transformers Power supplies Heaters Motors high inrush Reactive load
Number of poles		1 - 3; 1 + N; 3 + N	
Standards		UL489 and CSA-22.2 Nr. 5-09	
Short circuit withstand rating		10 kA	
Back-up fuse ≤ 10 kA short circuit withstand rating		none	
Rated voltage AC 50/60 Hz 0.3 - 32 A		277 / 480 V	
Rated voltage AC 50/60 Hz 40 - 63 A		240 V	
Rated current range		0.3 - 63 A	0.3 - 63 A
Test currents	Thermal not tripping $I_1 (A) > 1 \text{ h}$	$1.05 \times I_n$	$1.05 \times I_n$
	Thermal tripping $I_2 (A) < 1 \text{ h}$	$1.35 \times I_n$	$1.35 \times I_n$
	Electromagnetic not tripping $I_4 (A) > 0.1 \text{ s}$	$5 \times I_n$	$10 \times I_n$
	Electromagnetic tripping $I_5 (A) < 0.1 \text{ s}$	$10 \times I_n$	$16 \times I_n$
Reference calibration temperature of the thermal tripping		40 °C Influence of the ambient temperature on the thermal release: Decrease of the current values with higher ambient temperature and increase with lower temperatures of approximately 5 % per 10 °C difference in temperature	
Frequency range of the electromagnetic trip		16 <sup>2</sup> / <sub>3</sub> to 60 Hz With higher frequencies, the electromagnetic tripping values increase by approximately a factor of 1.1 at 100 Hz; 1.2 at 200 Hz; 1.3 at 300 Hz; 1.4 at 400 Hz; 1.5 for DC	
Ambient temperature		-25 °C to +55 °C	
Storage temperature		-40 °C to +70 °C	
Device depth according to DIN 43880		68 mm	
Mechanical life		10,000 switching cycles (ON / OFF)	
Protection cover		Finger safe and safe to back of hand according to DIN EN 50274, VDE 0660-514	
Degree of protection acc. EN / IEC 60529		IP20	
Installation position		any	
Mounting		DIN-rail according to DIN EN 60715 35 mm	
Lockability		The handle can be secured against manual switching in the on and off position by a lead seal	
Climatic resistance		Humid heat constant according to DIN EN 60068-2-78 Humid heat cycle according to DIN EN 60068-2-30	
Vibration resistance		> 15 g according to DIN EN 60068-2-59 during a load with $I_1$	
Resistance to mechanical shocks		25 g 11 ms	

\* Other switching devices in B and Z characteristics available on request

# Switching Devices

## Listed Circuit Breakers DC

according to UL489 and CSA-22.2 No. 5-09  
 Technical Data Product Range DL

Characteristic		C
Application		Lighting Wiring protection Control circuits Business equipment Appliances Motors low inrush
Number of poles		1 and 2
Standards		UL489 and CSA-22.2 Nr. 5-09
Short circuit withstand rating		10 kA
Back-up fuse $\leq$ 10 kA short circuit withstand rating		none
Rated voltage DC 1-pole		125 V
Rated voltage DC 2-pole		250 V
Rated current range		0.3 - 63 A
Test currents	Thermal not tripping $I_1$ (A) > 1 h	$1.05 \times I_n$
	Thermal tripping $I_2$ (A) < 1 h	$1.35 \times I_n$
	Electromagnetic not tripping $I_4$ (A) > 0.1 s	$7 \times I_n$
	Electromagnetic tripping $I_5$ (A) < 0.1 s	$14 \times I_n$
Reference calibration temperature of the thermal tripping		40 °C Influence of the ambient temperature on the thermal release: Decrease of the current values with higher ambient temperature and increase with lower temperatures of approximately 5 % per 10 °C difference in temperature
Ambient temperature		-25 °C to +55 °C
Storage temperature		-40 °C to +70 °C
Device depth according to DIN 43880		68 mm
Mechanical life		10,000 switching cycles (ON / OFF)
Protection cover		Finger safe and safe to back of hand according to DIN EN 50274, VDE 0660-514 BGV A3
Degree of protection acc. EN / IEC 60529		IP20
Installation position		any
Mounting		DIN-rail according to DIN EN 60715 35 mm
Lockability		The handle can be secured against manual switching in the on and off position by a lead seal
Climatic resistance		Humid heat constant according to DIN EN 60068-2-78 Humid heat cycle according to DIN EN 60068-2-30
Vibration resistance		> 15 g according to DIN EN 60068-2-59 during a load with $I_1$
Resistance to mechanical shocks		25 g 11 ms



File E 329510

Dimension drawings product ranges UL and DL

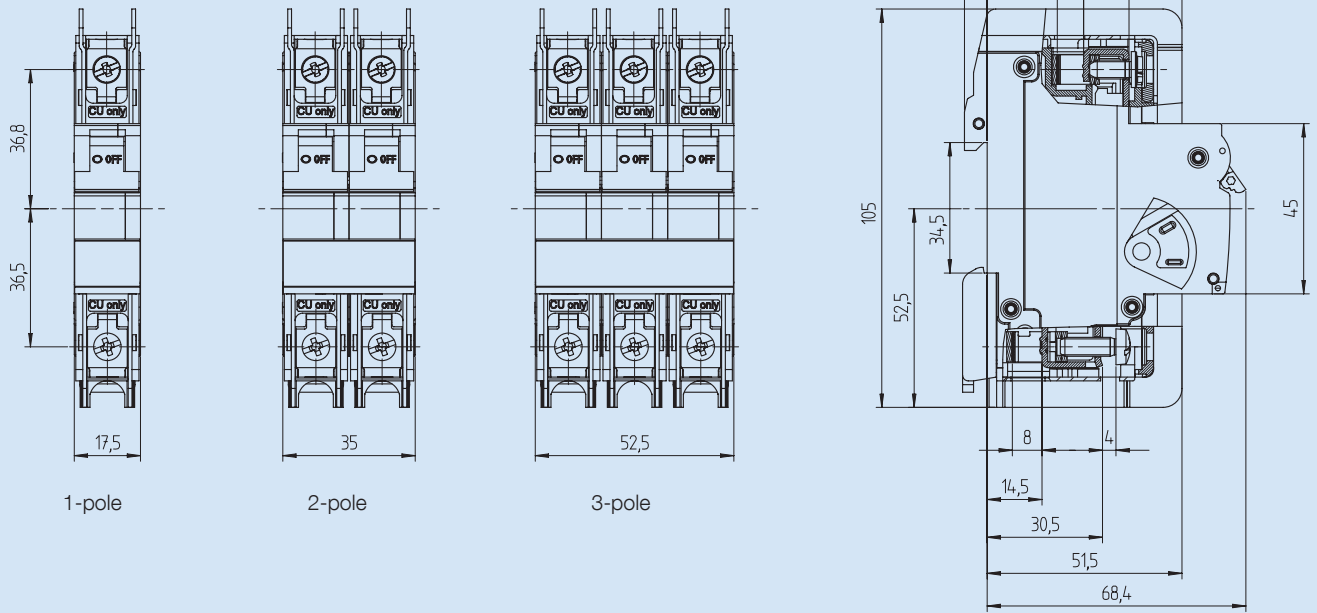



Type of conductor *)	Conductor cross sections			
	Box terminal bottom		Box terminal top	
	max.	min.	max.	min.
Single wire	35 mm <sup>2</sup> (AWG2)	1.0 mm <sup>2</sup> (AWG18)	25 mm <sup>2</sup> (AWG3)	1.0 mm <sup>2</sup> (AWG18)
Multiple wire	35 mm <sup>2</sup> (AWG2)	16 mm <sup>2</sup> (AWG6)	25 mm <sup>2</sup> (AWG3)	16 mm <sup>2</sup> (AWG6)
Stranded wire	25 mm <sup>2</sup> (AWG3)	1.0 mm <sup>2</sup> (AWG18)	16 mm <sup>2</sup> (AWG6)	1.0 mm <sup>2</sup> (AWG18)
Stranded wire with ferrule	16 mm <sup>2</sup> (AWG6)	1.0 mm <sup>2</sup> (AWG18)	16 mm <sup>2</sup> (AWG6)	1.0 mm <sup>2</sup> (AWG18)
Busbar cable lug	up to 3 mm thickness		up to 1.5 mm thickness	
Combined, conductor and busbar or cable lug	up to 35 mm <sup>2</sup> and up to 2 mm thickness		not possible	
Torque	max. 2.5 Nm (22.2 lb.in)			

\*) Stripped lengths: 12 - 14 mm at the bottom, 10 - 12 mm at the top  
( ) values in brackets = measurement units for North America  
Copper conductor with sheath insulation for 60/75 °C

## Internal Resistance for Product Ranges UL and DL

Rated current [A]	Trip characteristic	
	C [Ohm]	D [Ohm]
0.3	16.8620	16.8620
0.5	6.8540	6.0009
1.0	1.7000	1.7560
1.6	0.5870	0.5870
2.0	0.4190	0.4190
3.0	0.2020	0.2020
4.0	0.1090	0.1090
5.0	0.0654	0.0654
6.0	0.0528	0.0491
8.0	0.0278	0.0240
10	0.0216	0.0187
12	0.0084	0.0085
13	0.0084	0.0085
15/16	0.0085	0.0076
20	0.0067	0.0064
25	0.0050	0.0041
30/32	0.0032	0.0027
40	0.0025	0.0022
50	0.0019	0.0018
60/63	0.0018	0.0017

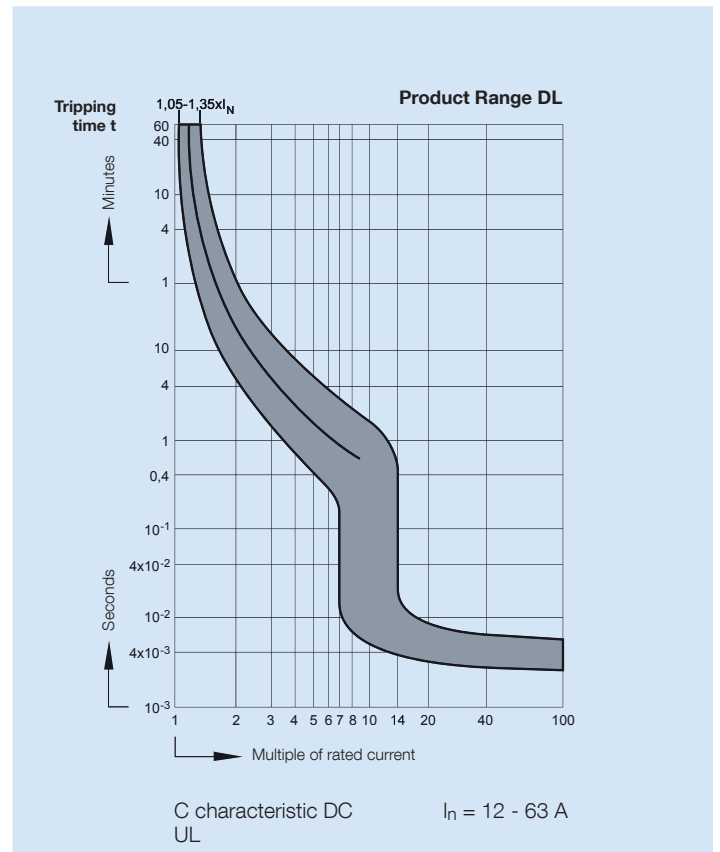
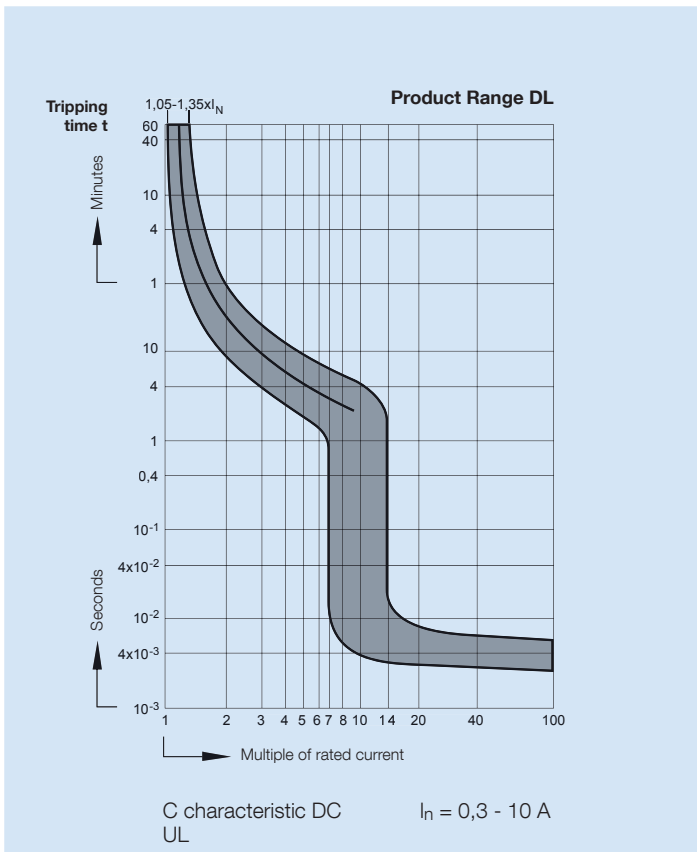
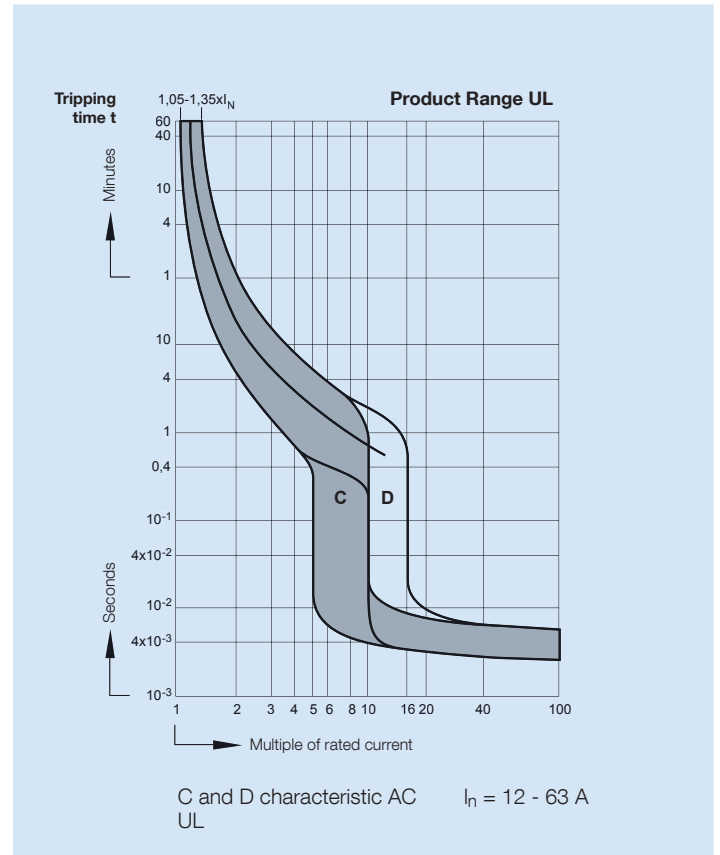
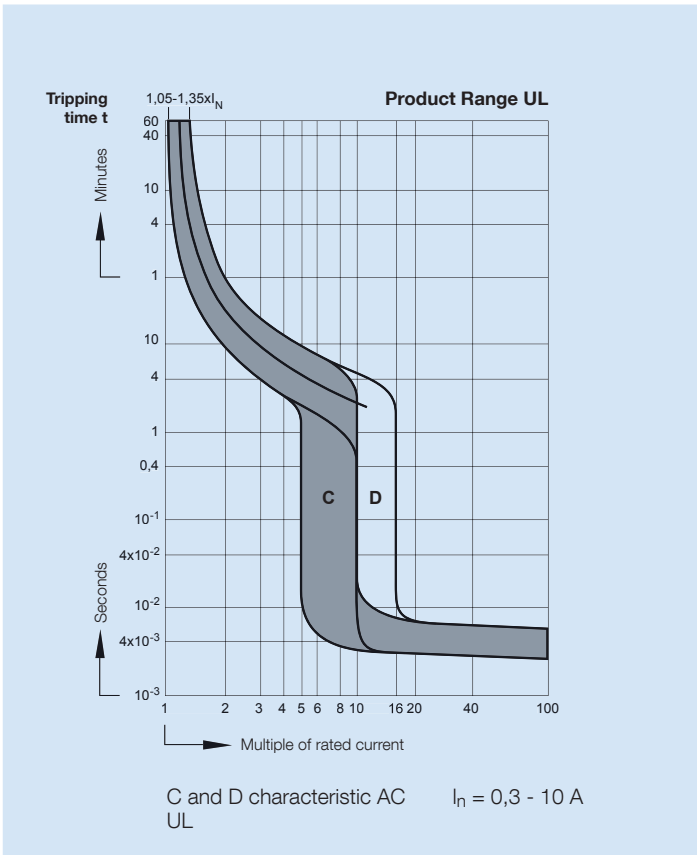





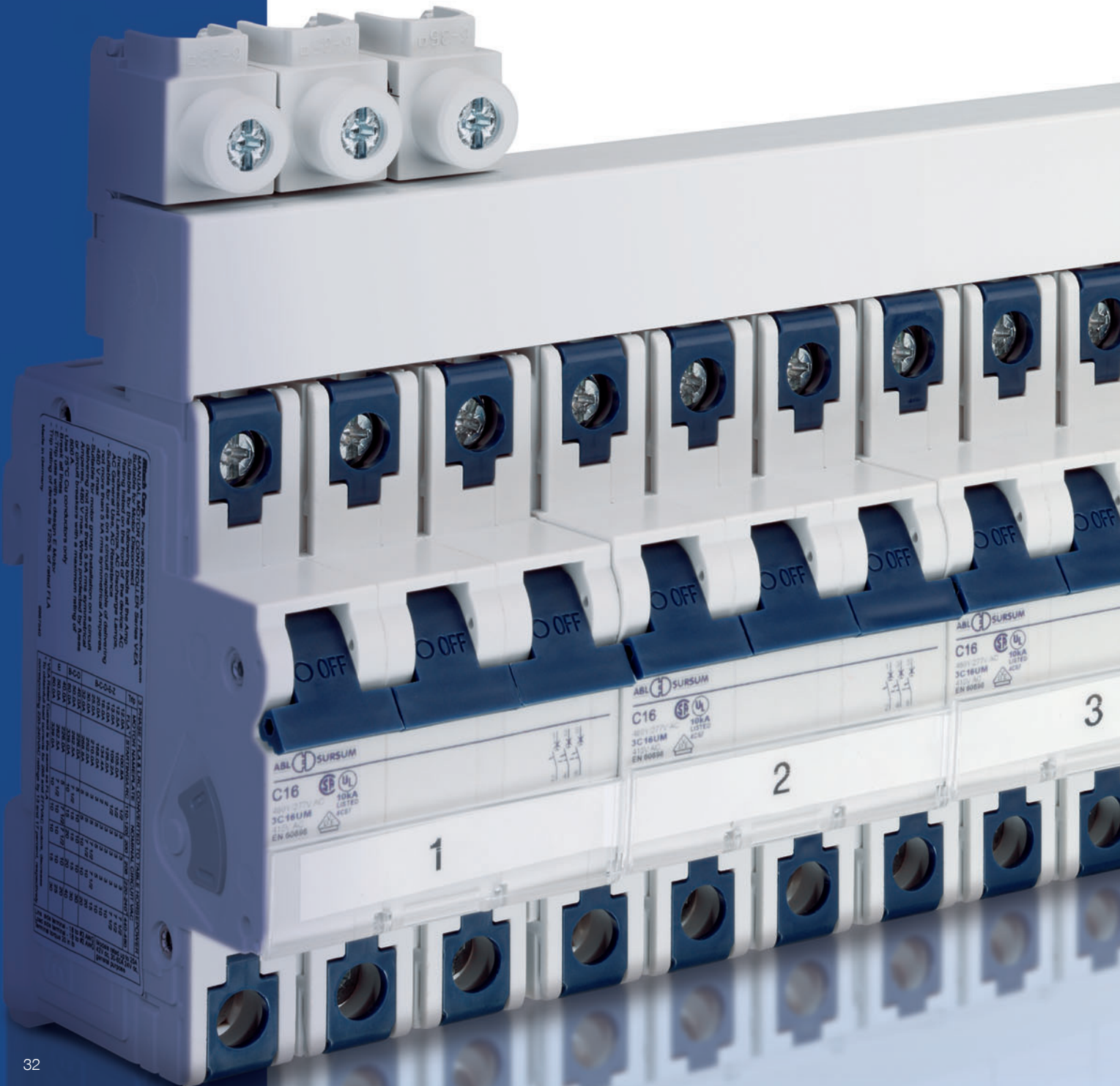

---

## ABL SURSUM Switching Devices according to UL508 and CSA-22.2 no. 14



Manual motor controllers according to UL508 and CSA-22.2 are considered to be control equipment without the function of short circuit protection.

Our range of UL508 motor controllers in the design of a “miniature circuit breaker” offers a convenient installation solution with the availability of single and double pole versions – especially for single phase motors.

They are “Suitable as Motor Disconnect” and they can be used for “Motor Starting Across the Line”. In addition, with the wide range of tripping characteristics, it is the ideal protection in some specific applications.

The “Z” characteristic offers the best protection of electronic devices, semiconductors and components with low surge currents and withstand capabilities.

Our range offers 1, 2 and 3 pole devices, available in the UL characteristics G and E, as well as in the IEC characteristics B, C, D, and Z. In combination with the typical nominal ratings of both standards, we can offer the ideal protection in each application.

Our system is most convenient for applications up to 25 A, where our devices carry the IEC and the UL approval. Together with UL approved busbar technology, the installation can be easily adapted for both standards, and offers OEMs to broadly standardise the electrical installation independently of the location where the equipment will later be used.



File E137938

**European-type of busbar wiring tested and approved for UL**  
(at least one motor contained in the circuit)

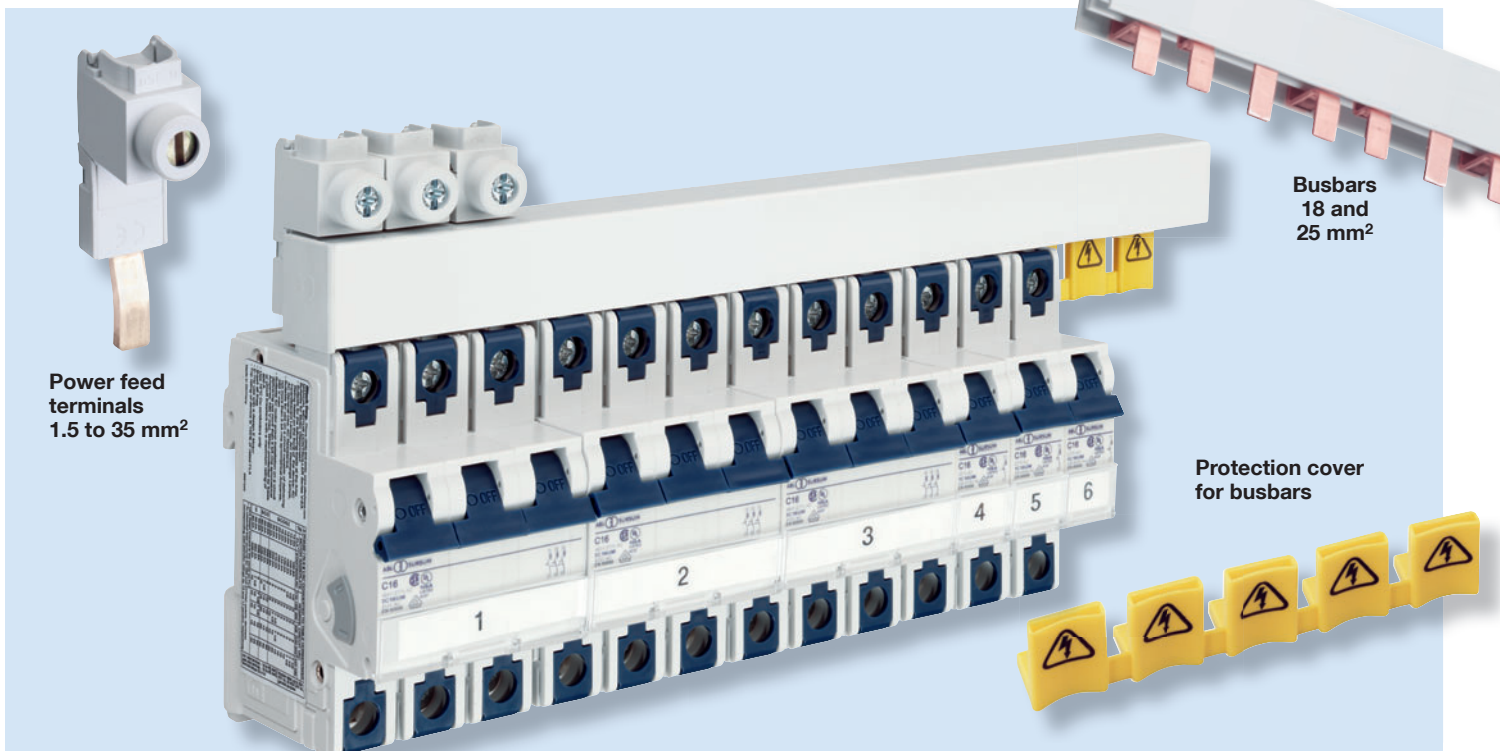

## UL-approved accessories

File E137938

### Switching devices

1-pole to 3-pole  
Neutral switch  
can be mounted

Characteristic:  
B, C, D, E, G and Z

Rated currents:  
0.3 to 63 A  
(63 A without UL approval)

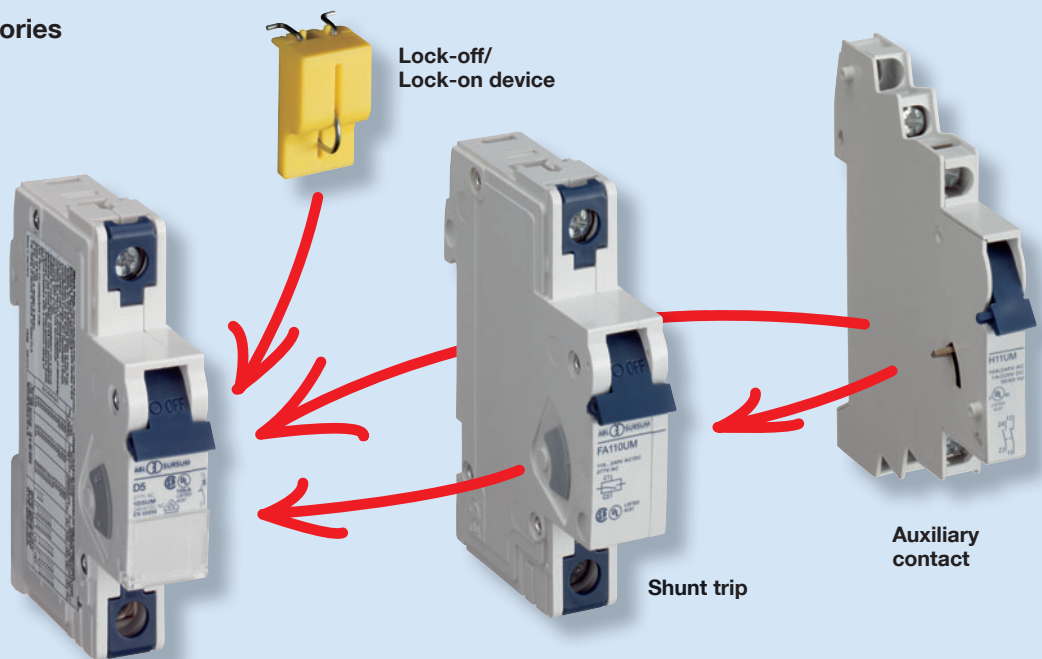

# Switching Devices Manual Motor Controller

according to UL508 and CSA-22.2 No.14  
UM Product Range, B, C, D,G, E and Z Characteristic  
B, C and D also acc. to IEC 60898-1, DIN EN 60898-1,  
VDE 0641-11 (B, C, D Characteristic 0.3 - 25 A)



Rated current $I_n$ A	Characteristic						Weight g/each	Packing unit
	B Article no.	C Article no.	D Article no.	G Article no.	E Article no.	Z Article no.		

1-pole								
0.3		1C03UM	1D03UM	1G03UM	1E03UM	1Z03UM	150	12
0.5		1C05UM	1D05UM	1G05UM	1E05UM	1Z05UM	150	12
0.75		1C075UM	1D075UM		1E075UM	1Z075UM	150	12
0.8				1G08UM				
1	1B1UM	1C1UM	1D1UM	1G1UM	1E1UM	1Z1UM	150	12
1.6	1B1.6UM	1C1.6UM	1D1.6UM	1G1.6UM	1E1.6UM	1Z1.6UM	150	12
2	1B2UM	1C2UM	1D2UM	1G2UM	1E2UM	1Z2UM	150	12
2.5	1B2.5UM	1C2.5UM	1D2.5UM	1G2.5UM	1E2.5UM	1Z2.5UM	150	12
3	1B3UM	1C3UM	1D3UM	1G3UM	1E3UM	1Z3UM	150	12
3.5	1B3.5UM	1C3.5UM	1D3.5UM	1G3.5UM	1E3.5UM	1Z3.5UM	150	12
4	1B4UM	1C4UM	1D4UM	1G4UM	1E4UM	1Z4UM	150	12
5	1B5UM	1C5UM	1D5UM	1G5UM	1E5UM	1Z5UM	150	12
6	1B6UM	1C6UM	1D6UM	1G6UM	1E6UM	1Z6UM	150	12
8		1C8UM	1D8UM	1G8UM	1E8UM	1Z8UM	150	12
10	1B10UM	1C10UM	1D10UM	1G10UM	1E10UM	1Z10UM	150	12
12				1G12UM		1Z12UM		
13	1B13UM	1C13UM	1D13UM	1G13UM	1E13UM	1Z13UM	150	12
15	1B15UM	1C15UM	1D15UM	1G15UM	1E15UM	1Z15UM		
16	1B16UM	1C16UM	1D16UM	1G16UM	1E16UM	1Z16UM	150	12
20	1B20UM	1C20UM	1D20UM	1G20UM	1E20UM	1Z20UM	150	12
25	1B25UM	1C25UM	1D25UM	1G25UM	1E25UM	1Z25UM	150	12
30	1B30UM	1C30UM	1D30UM	1G30UM	1E30UM	1Z30UM		
32	1B32UM	1C32UM	1D32UM	1G32UM	1E32UM	1Z32UM	150	12
40	1B40UM	1C40UM	1D40UM	1G40UM	1E40UM	1Z40UM	150	12
50	1B50UM	1C50UM	1D50UM	1G50UM	1E50UM	1Z50UM	150	12
60	1B60UM	1C60UM	1D60UM	1G60UM	1E60UM		150	12
63 *	1B63UM	1C63UM	1D63UM	1G63UM	1E63UM		150	12

\* 63 A without UL approval



# Switching Devices Manual Motor Controller

according to UL508 and CSA-22.2 No.14  
UM Product Range, B, C, D,G, E and Z Characteristic  
B, C and D also acc. to IEC 60898-1, DIN EN 60898-1,  
VDE 0641-11 (B, C, D Characteristic 0.3 - 25 A)



Rated current $I_n$ A	Characteristic						Weight g/each	Packing unit
	B Article no.	C Article no.	D Article no.	G Article no.	E Article no.	Z Article no.		

2-pole								
0.3		2C03UM	2D03UM	2G03UM	2E03UM	2Z03UM	300	6
0.5		2C05UM	2D05UM	2G05UM	2E05UM	2Z05UM	300	6
0.75		2C075UM	2D075UM		2E075UM	2Z075UM	300	6
0.8				2G08UM				
1	2B1UM	2C1UM	2D1UM	2G1UM	2E1UM	2Z1UM	300	6
1.6		2C1.6UM	2D1.6UM	2G1.6UM	2E1.6UM	2Z1.6UM	300	6
2		2C2UM	2D2UM	2G2UM	2E2UM	2Z2UM	300	6
2.5		2C2.5UM	2D2.5UM	2G2.5UM	2E2.5UM	2Z2.5UM	300	6
3	2B3UM	2C3UM	2D3UM	2G3UM	2E3UM	2Z3UM	300	6
3.5		2C3.5UM	2D3.5UM	2G3.5UM	2E3.5UM	2Z3.5UM	300	6
4	2B4UM	2C4UM	2D4UM	2G4UM	2E4UM	2Z4UM	300	6
5	2B5UM	2C5UM	2D5UM	2G5UM	2E5UM	2Z5UM	300	6
6	2B6UM	2C6UM	2D6UM	2G6UM	2E6UM	2Z6UM	300	6
8		2C8UM	2D8UM	2G8UM	2E8UM	2Z8UM	300	6
10	2B10UM	2C10UM	2D10UM	2G10UM	2E10UM	2Z10UM	300	6
12				2G12UM		2Z12UM		
13	2B13UM	2C13UM	2D13UM	2G13UM	2E13UM	2Z13UM	300	6
15	2B15UM	2C15UM	2D15UM	2G15UM	2E15UM	2Z15UM		
16	2B16UM	2C16UM	2D16UM	2G16UM	2E16UM	2Z16UM	300	6
20	2B20UM	2C20UM	2D20UM	2G20UM	2E20UM	2Z20UM	300	6
25	2B25UM	2C25UM	2D25UM	2G25UM	2E25UM	2Z25UM	300	6
30	2B30UM	2C30UM	2D30UM	2G30UM	2E30UM	2Z30UM		
32	2B32UM	2C32UM	2D32UM	2G32UM	2E32UM	2Z32UM	300	6
40	2B40UM	2C40UM	2D40UM	2G40UM	2E40UM	2Z40UM	300	6
50	2B50UM	2C50UM	2D50UM	2G50UM	2E50UM	2Z50UM	300	6
60	2B60UM	2C60UM	2D60UM	2G60UM	2E60UM		300	6
63 *	2B63UM	2C63UM	2D63UM	2G63UM	2E63UM		300	6

\* 63 A without UL approval

# Switching Devices Manual Motor Controller

according to UL508 and CSA-22.2 No.14  
UM Product Range, B, C, D,G, E and Z Characteristic  
B, C and D also acc. to IEC 60898-1, DIN EN 60898-1,  
VDE 0641-11 (B, C, D Characteristic 0.3 - 25 A)



Rated current $I_n$ A	Characteristic						Weight g/each	Packing unit
	B Article no.	C Article no.	D Article no.	G Article no.	E Article no.	Z Article no.		

3-pole								
0.3		3C03UM	3D03UM	3G03UM	3E03UM	3Z03UM	450	4
0.5		3C05UM	3D05UM	3G05UM	3E05UM	3Z05UM	450	4
0.75		3C075UM	3D075UM		3E075UM	3Z075UM	450	4
0.8				3G08UM				
1	3B1UM	3C1UM	3D1UM	3G1UM	3E1UM	3Z1UM	450	4
1.6	3B1.6UM	3C1.6UM	3D1.6UM	3G1.6UM	3E1.6UM	3Z1.6UM	450	4
2	3B2UM	3C2UM	3D2UM	3G2UM	3E2UM	3Z2UM	450	4
2.5	3B2.5UM	3C2.5UM	3D2.5UM	3G2.5UM	3E2.5UM	3Z2.5UM	450	4
3	3B3UM	3C3UM	3D3UM	3G3UM	3E3UM	3Z3UM	450	4
3.5	3B3.5UM	3C3.5UM	3D3.5UM	3G3.5UM	3E3.5UM	3Z3.5UM	450	4
4	3B4UM	3C4UM	3D4UM	3G4UM	3E4UM	3Z4UM	450	4
5	3B5UM	3C5UM	3D5UM	3G5UM	3E5UM	3Z5UM	450	4
6	3B6UM	3C6UM	3D6UM	3G6UM	3E6UM	3Z6UM	450	4
8		3C8UM	3D8UM	3G8UM	3E8UM	3Z8UM	450	4
10	3B10UM	3C10UM	3D10UM	3G10UM	3E10UM	3Z10UM	450	4
12				3G12UM		3Z12UM		
13	3B13UM	3C13UM	3D13UM	3G13UM	3E13UM	3Z13UM	450	4
15	3B15UM	3C15UM	3D15UM	3G15UM	3E15UM	3Z15UM		
16	3B16UM	3C16UM	3D16UM	3G16UM	3E16UM	3Z16UM	450	4
20	3B20UM	3C20UM	3D20UM	3G20UM	3E20UM	3Z20UM	450	4
25	3B25UM	3C25UM	3D25UM	3G25UM	3E25UM	3Z25UM	450	4
30	3B30UM	3C30UM	3D30UM	3G30UM	3E30UM	3Z30UM		
32	3B32UM	3C32UM	3D32UM	3G32UM	3E32UM	3Z32UM	450	4
40	3B40UM	3C40UM	3D40UM	3G40UM	3E40UM	3Z40UM	450	4
50	3B50UM	3C50UM	3D50UM	3G50UM	3E50UM	3Z50UM	450	4
60	3B60UM	3C60UM	3D60UM	3G60UM	3E60UM		450	4
63 *	3B63UM	3C63UM	3D63UM	3G63UM	3E63UM		450	4

\* 63 A without UL approval



Rated current $I_n$ A	Rated voltage Volt AC	Test currents * electromagnetic		Article no.	Weight g/each	Packing unit
		not tripping $I_4$ A	tripping $I_5$ A			

Neutral switch – for mounting instructions please consult page 39						
0.3 - 63	277/480	400	700	N63UM	150	5

\* additional electromagnetic protection

according to UL508 and CSA-22.2 No.14  
for Product Ranges UM and UR



File E137938



Auxiliary contact					
Module	Type of contact	Contacts	Article no.	Weight g/each	Packing unit
1/2	1 auxiliary contact	1NO	<b>H10UM</b>	35	10
1/2	2 auxiliary contacts	1NO + 1NC	<b>H11UM</b>	40	10
1/2	3 auxiliary contacts	1NO + 2NC	<b>H12UM</b>	45	10
1/2	3 auxiliary contacts	2NO + 1NC	<b>H21UM</b>	45	10

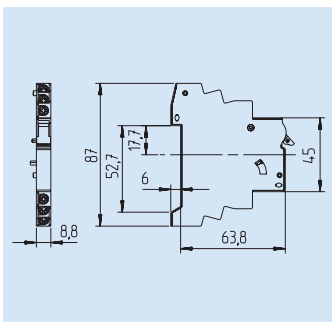

Standards	Acc. to IEC 60947-5-1, DIN EN 60947-5-1, VDE 0660-200, UL508	
Rated operating currents	10 A / 240 V AC 3 A / 110 V DC 1 A / 220 V DC	
Minimum contact load	1 mA at 24 V DC	
Conductor cross sections		
Type of conductor *)	min.	max.
Single wire	1.0 mm <sup>2</sup> (AWG18)	2.5 mm <sup>2</sup> (AWG14)
Stranded wire	1.0 mm <sup>2</sup> (AWG18)	1.5 mm <sup>2</sup> (AWG16)
Stranded wire with ferrule	1.0 mm <sup>2</sup> (AWG18)	1.5 mm <sup>2</sup> (AWG16)
Torque	max. 0.8 Nm (7 lb.in)	

\*) Stripped length 8 - 9 mm



Shunt trip					
Module	Rated operating voltage	max. operating current at U <sub>n</sub> (t < 10 ms)	Article no.	Weight g/each	Packing unit
1	12 V UC	1.3 A	<b>FA12UM</b>	105	5
1	24 V UC	0.6 A	<b>FA24UM</b>	105	5
1	48 - 74 V UC	0.2 A	<b>FA48UM</b>	105	5
1	110 - 240 V UC, 415 V AC	0.25 A at 110 V 0.5 A at 240 V 0.58 A at 277 V	<b>FA110UM</b>	105	5



Lock-off/Lock-on device		
Article no.	Weight g/each	Packing unit
<b>EASS</b>	2	10

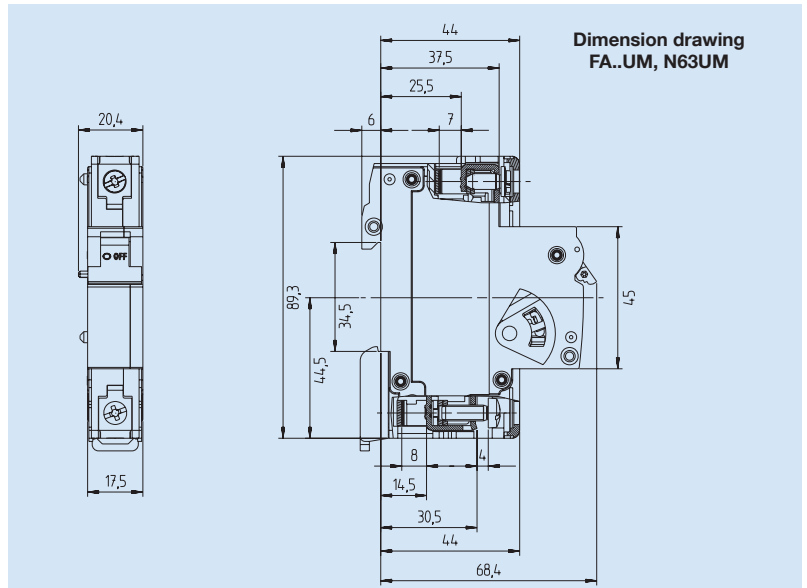

## Mounting Instructions of Accessories

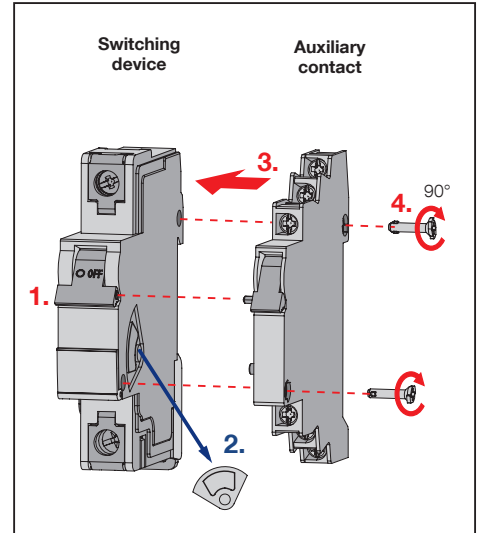
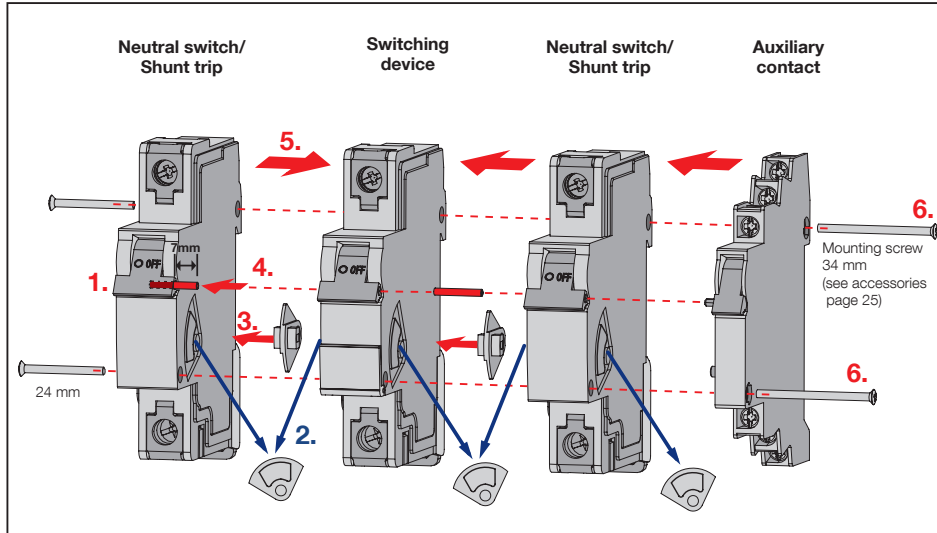

**Applies to N...UM and FA...UM:**  
The accessory devices N...UM and FA...UM can be mounted **on the right or left**.  
The auxiliary contact H...UM can only be mounted **on the right**.

- Mounting:**
1. Bring the blue knobs of all devices into the "OFF" position
  2. Remove grey cover from the switching device and attachment
  3. Insert drive plate between the switching device and N...UM or FA...UM
  4. Insert connecting pin into the knob (insertion depth approx. 7 mm)
  5. Combine switching device and N...UM or FA...UM
  6. Screw devices together (observe correct screw length)

**Applies to H...UM:**  
The auxiliary contact H...UM can only be mounted **on the right**.

- Mounting:**
1. Bring the blue knobs of both devices into the "OFF" position
  2. Remove grey cover from the switching device
  3. Combine switching device and H...UM
  4. Insert connection screws and connect the two devices by turning the screws by 90°
  5. After mounting close and open to check operation

### Applies to all switching devices ...UM, N63UM and FA...UM:

The load and mains can be connected either from the top or the bottom (Line/Load Reversible).



Box terminal for  
• solid conductors  
• flexible conductors  
with or without cable lug



Screw terminal  
for forked cable lug



Screw terminal  
for ring cable lug  
(ring tongue)

### Design of the terminals

- Optical detection of the screw position
- Increased break resistance if the screwdriver becomes jammed
- Universal connecting terminals, suitable for connecting all known cable lugs such as ring or forked cable lugs and pin terminals
- Ring cable lugs can be connected by opening the flap and removing the connecting screw
- Can also be used for applications that require ring cable lugs (e.g. nuclear power stations)
- Protection against contact with live parts according to DIN EN 50274, VDE 0660-514 is fully guaranteed

# Busbars for Switching Devices Manual Motor Controller

according to UL508 and CSA-22.2 No.14  
for Product Ranges UM and MA...UM

Cross section (mm <sup>2</sup> )	Busbar current Start of busbar/ Middle infeed	Modules/ Phases	Article no.	Weight g/each	Packing unit	Suitable end cap Article no.
----------------------------------	---	--------------------	-------------	------------------	-----------------	------------------------------------

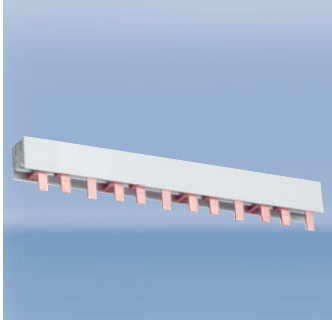

<b>Busbars pin type acc. to UL and CSA</b>						
<b>1-phase</b>						
18	80/130	57	<b>SB.U1</b>	300	1	
<b>1-phase 1-pole switching device + auxiliary contact</b>						
18	80/130	37/1	<b>SB.U1H</b>	280	1	
<b>3-phase</b>						
18	80/130	19/3	<b>SB.U3</b>	800	1	SB.U8
<b>3-phase 3-pole switching device + auxiliary contact</b>						
25	100/180	16/3	<b>SB.U3H</b>	1020	1	SB.U8

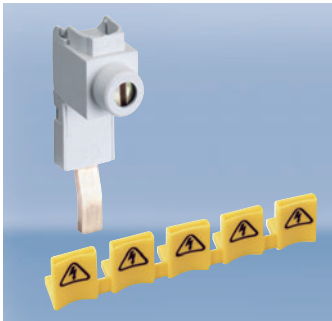

<b>Power feed terminals</b>						
6 - 35	115		<b>AK.U1</b>	35	1	

<b>Protection cover for busbars UL and CSA</b>						
			<b>SB.U9</b>	0.6/3		1 strip = 5 pieces



# Busbars

for Manual Motor Controllers, Product Ranges UM and MA...UM

Cross section [mm <sup>2</sup> ]	Busbar current Start of busbar/ Middle infeed	Modules/ Phases	Article no.	Weight g/each	Packing unit	Suitable end cap Article no.
----------------------------------	---	--------------------	-------------	------------------	-----------------	------------------------------------

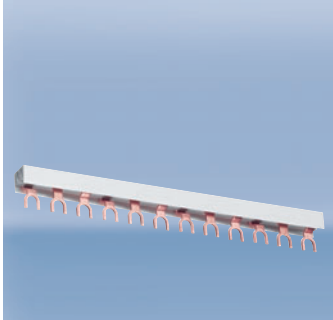

Busbars fork type without UL and CSA approval						
<b>1-phase</b>						
12	65/110	56/1	<b>SB16010</b>	250	50	
<b>1-phase 1-pole switching device + auxiliary contact</b>						
24	90/150	37/1	<b>SDO.124</b>	200	50	
<b>2-phase and 1-phase + N</b>						
10	63/100	28/2	<b>SB26010</b>	390	20	SB.A5
<b>2-phase 2-pole switching device + auxiliary contact</b>						
16	80/130	22/2	<b>SB26216</b>	310	20	SB.A2
<b>3-phase</b>						
10	63/100	4/3	<b>SB31210</b>	84	25	SB.A1
10	63/100	19/3	<b>SB36010</b>	420	20	SB.A1
16	80/130	19/3	<b>SB36016</b>	675	20	SB.A2
<b>3-phase 3-pole switching device + auxiliary contact</b>						
16	80/130	16/3	<b>SB36316</b>	630	20	SB.A2
<b>3-phase 1-pole switching device + auxiliary contact</b>						
16	80/130	36/1	<b>SDO.316</b>	500	20	SB.A2
<b>4-phase and 3-phase + N</b>						
16	80/130	14/4	<b>SB46016</b>	835	15	SB.A3

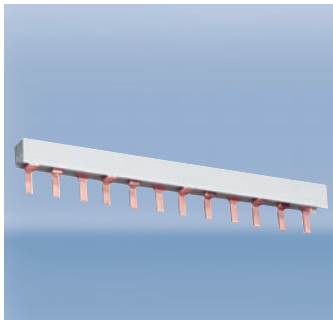

Busbars pin type without UL and CSA approval						
<b>3-phase</b>						
16	80/130	19/3	<b>SB718U</b>	500	20	SB.A2



File E137938

Characteristic		B	C	D	E	G	Z
Application		Lighting Circuits control Wiring protection Business equipment Appliances	Lighting Circuits control Wiring protection Business equipment Appliances Motors low inrush	Transformers Power supplies Reactive load Motors high inrush	Transformers Power supplies Motors high efficiency	Lighting Circuits control Wiring protection Transformers Solenoid Motors general	Wiring protection Semiconductor protection General electronics
Number of poles		1 - 3; 1 + N; 3 + N					
Standards		IEC 60898-1, DIN EN 60898-1, VDE 0641-11, UL508, CSA-22.2 No.14					
Short circuit withstand rating		see data sheet for use in the USA, Canada and Europe (page 44)					
Current limiting class		3	3				
Max. back-up fuse		see data sheet for use in the USA, Canada and Europe (page 44)					
Rated voltage AC		277 / 480 V					
Rated voltage DC L/R = 4 ms		1-pole 42 V and 2-poles 80 V in serial connection of both poles (up to 25 A rated current)					
		1-pole 24 V and 2-poles 60 V in serial connection of both poles (30 A - 60 A rated current)					
Rated current range		1 - 63* A	0.3 - 63* A	0.3 - 63* A	0.3 - 63* A	0.3 - 63* A	0.3 - 50 A
Test currents	Thermal not tripping $I_1 (A) > 1 \text{ h}$	$1.13 \times I_n$	$1.13 \times I_n$	$1.13 \times I_n$	$1.05 \times I_n$	$1.05 \times I_n$	$1.05 \times I_n$
	Thermal tripping $I_2 (A) < 1 \text{ h}$	$1.45 \times I_n$	$1.45 \times I_n$	$1.45 \times I_n$	$1.35 \times I_n$	$1.35 \times I_n$	$1.35 \times I_n$
	Electromagnetic not tripping $I_4 (A) > 0,1 \text{ s}$	$3 \times I_n$	$5 \times I_n$	$10 \times I_n$	$14 \times I_n$	$8 \times I_n$	$2 \times I_n$
	Electromagnetic tripping $I_5 (A) < 0,1 \text{ s}$	$5 \times I_n$	$10 \times I_n$	$16 \times I_n$	$18 \times I_n$	$10 \times I_n$	$3 \times I_n$
Reference calibration temperature of the thermal tripping		30° C + 5° C			20° C + 5° C		
		Influence of the ambient temperature on the thermal release: Decrease of the current values with higher ambient temperature and increase with lower temperatures of approximately 5% per 10°C difference in temperature					
Frequency range of the electromagnetic trip		16 <sup>2/3</sup> to 60 Hz With higher frequencies, the electromagnetic tripping values increase by approximately a factor of 1.1 at 100 Hz; 1.2 at 200 Hz; 1.3 at 300 Hz; 1.4 at 400 Hz; 1.5 for DC					
Ambient temperature		-25 °C to +55 °C					
Storage temperature		-40 °C to +70 °C					
Device depth according to DIN 43880		68 mm					
Mechanical life		10,000 switching cycles (ON / OFF)					
Protection cover		Finger safe and safe to back of hand according to DIN EN 50274/ VDE0660-514, BGV A3					
Insulation group acc. to DIN/VDE 0110		C at 250 V AC B at 400 V AC					
Degree of protection acc. to EN/IEC 60529		IP20					
Installation position		any					
Mounting		DIN-rail according to DIN EN 60715 35 mm					
Lockability		The handle can be secured against manual switching in the on and off position by a lead seal					
Climatic resistance		Humid heat constant according to DIN EN 60068-2-78 Humid heat cycle according to DIN EN 60068-2-30					
Vibration resistance		> 15 g according to DIN EN 60068-2-59 during a load with $I_1$					
Resistance to mechanical shocks		25g 11ms					

\* 63 A without UL approval

Type of conductor *)	Conductor cross sections			
	Box terminal bottom		Box terminal top	
	max.	min.	max.	min.
Single wire	35 mm <sup>2</sup> (AWG2)	1.0 mm <sup>2</sup> (AWG18)	25 mm <sup>2</sup> (AWG3)	1.0 mm <sup>2</sup> (AWG18)
Multiple wire	35 mm <sup>2</sup> (AWG2)	16 mm <sup>2</sup> (AWG6)	25 mm <sup>2</sup> (AWG3)	16 mm <sup>2</sup> (AWG6)
Stranded wire	25 mm <sup>2</sup> (AWG3)	1.0 mm <sup>2</sup> (AWG18)	16 mm <sup>2</sup> (AWG6)	1.0 mm <sup>2</sup> (AWG18)
Stranded wire with ferrule	16 mm <sup>2</sup> (AWG6)	1.0 mm <sup>2</sup> (AWG18)	16 mm <sup>2</sup> (AWG6)	1.0 mm <sup>2</sup> (AWG18)
Busbar cable lug	up to 3 mm thickness		up to 1.5 mm thickness	
Combined, conductor and busbar or cable lug	up to 35 mm <sup>2</sup> and up to 2 mm thickness		not possible	
Torque	max. 2.5 Nm (22.2 lb.in)			

\*) Stripped length: bottom 12 - 14 mm, top 10 - 12 mm

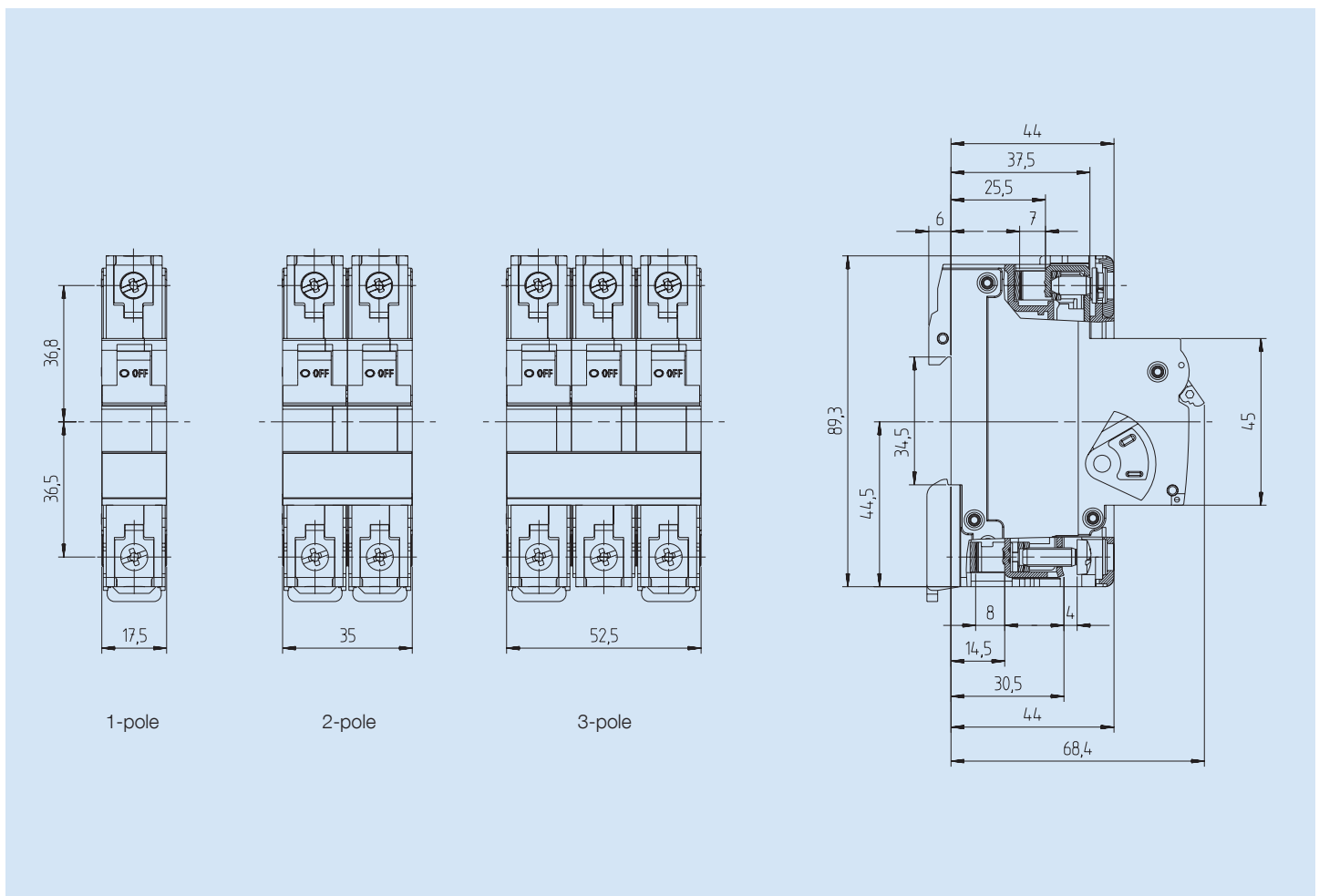

### Short circuit withstand rating and maximum back-up fuse according to UL508 and CSA-22.2 No.14

Characteristic	B; C; D; E; G and Z				
Standards	UL508 and CSA-22.2 No.14				
	Number of poles	Maximum rated voltage V	Rated current A	Short circuit withstand rating kA	Maximum back-up fuse A
Short circuit withstand rating at rated voltage Ambient temperature 40 °C	1 / 1 + N	277	0.3 - 10	10	70 A
	1 / 1 + N	277	12 - 60	10	4 x I <sub>n</sub>
	2 / 3 / 3 + N	480	0.3 - 10	10	70 A
	2 / 3 / 3 + N	480	12 - 60	10	4 x I <sub>n</sub>
Back-up fuse for group installations	1 / 1 + N	277	0.3 - 10	10	800 A
	1 / 1 + N	277	12 - 60	5	800 A
	2 / 3 / 3 + N	480	0.3 - 10	10	800 A
	2 / 3 / 3 + N	480	12 - 60	5	800 A

### Short circuit withstand rating and maximum back-up fuse according to EN and IEC

Characteristic	B; C; D; E; G and Z				
Standards	IEC 60947-2, DIN EN 60947-2, VDE 0660-101 B, C and D characteristic acc. to IEC 60898-1, DIN EN 60898-1, VDE 0641-11				
	Number of poles	Maximum rated voltage V	Rated current A	Short circuit withstand rating kA	Maximum back-up fuse A
Short circuit withstand rating at rated voltage	1 / 1 + N	277	0.3 - 60	10	160
	2 / 3 / 3 + N	480	0.3 - 60	10	160

### Internal Resistance for Product Ranges UM and UR

Rated current [A]	Trip characteristic]					
	B [Ohm]	C [Ohm]	D [Ohm]	G [Ohm]	E [Ohm]	Z [Ohm]
0.3		16.8620	16.8620	16.862	14.52000	31.5060
0.5		6.8540	6.0009	6.854	5.92000	10.2460
0.75/0.8		3.0540	3.0540	3.054	2.70000	5.3920
1.0	1.7000	1.7000	1.7560	1.756	1.48000	2.6910
1.6	0.5870	0.5870	0.5870	0.587	0.57400	0.9440
2.0	0.4190	0.4190	0.4190	0.419	0.40500	0.8900
2.5	0.2950	0.2950	0.2950	0.295	0.26900	0.4290
3.0	0.2020	0.2020	0.2020	0.202	0.18600	0.3460
3.5	0.1390	0.1390	0.1390	0.139	0.13900	0.1790
4.0	0.1090	0.1090	0.1090	0.109	0.10600	0.1620
5.0	0.0654	0.0654	0.0654	0.0654	0.05900	0.1050
6.0	0.0528	0.0528	0.0491	0.0491	0.04600	0.0823
8.0		0.0278	0.0240	0.0333	0.03040	0.0371
10	0.0216	0.0216	0.0187	0.0211	0.02020	0.0278
12				0.0084	0.00724	0.0151
13	0.0113	0.0084	0.0085	0.0084	0.00724	0.0151
15/16	0.0085	0.0085	0.0076	0.0076	0.00731	0.0114
20	0.0067	0.0067	0.0064	0.0064	0.00582	0.0075
25	0.0050	0.0050	0.0041	0.0046	0.00411	0.0050
30/32	0.0032	0.0032	0.0027	0.003	0.00272	0.0032
40	0.0025	0.0025	0.0022	0.0022	0.00212	0.0022
50	0.0019	0.0019	0.0018	0.0019	0.00184	0.0020
60/63 *	0.0018	0.0018	0.0017	0.00179	0.00172	—

\* 63 A without UL approval



File E137938

Ampere rating and horsepower rating 1 phase								
			FLA and LRC converted to table horsepower (see Note 2) use FLA and LRC ratings where no hp rating is given					
Rated current [A] (see Note 1)	Motor nameplate FLA rating [A]	Motor nameplate Starting/ LCR rating [A]	Nominal circuit voltage					
			110 – 120 VAC [hp]	200 VAC [hp]	208 VAC [hp]	220 – 240 VAC [hp]	265 VAC [hp]	277 VAC [hp]
<b>0.30</b> <b>0.50</b> <b>0.75</b>	0.30 0.50 0.75	1.80 3.00 4.35						
<b>0.80</b> <b>1.0</b> <b>1.6</b>	0.80 1.0 1.6	4.8 6.0 9.6						
<b>2.0</b> <b>2.5</b> <b>3.0</b>	2.0 2.5 3.0	12.0 15.0 18.0		$\frac{1}{6}$ $\frac{1}{6}$	$\frac{1}{6}$ $\frac{1}{6}$	$\frac{1}{6}$ $\frac{1}{4}$	$\frac{1}{6}$ $\frac{1}{4}$	$\frac{1}{6}$ $\frac{1}{4}$ $\frac{1}{3}$
<b>3.5</b> <b>4.0</b>	3.5 4.0	21.0 24.0		$\frac{1}{4}$ $\frac{1}{4}$	$\frac{1}{4}$ $\frac{1}{3}$	$\frac{1}{4}$ $\frac{1}{3}$	$\frac{1}{3}$ $\frac{1}{3}$	$\frac{1}{3}$ $\frac{1}{3}$
<b>5.0</b> <b>6.0</b> <b>8.0</b>	5.0 6.0 8.0	30.0 36.0 48.0	$\frac{1}{6}$ $\frac{1}{4}$ $\frac{1}{3}$	$\frac{1}{3}$ $\frac{1}{2}$ $\frac{3}{4}$	$\frac{1}{2}$ $\frac{1}{2}$ $\frac{3}{4}$	$\frac{1}{2}$ $\frac{1}{2}$ 1	$\frac{1}{2}$ $\frac{3}{4}$ 1	$\frac{1}{2}$ $\frac{3}{4}$ 1
<b>10.0</b>	10	60.0	$\frac{1}{2}$	1	1	1 $\frac{1}{2}$	1 $\frac{1}{2}$	2
<b>12.0</b> <b>12.5</b>	12.0 12.5	72.0 75.0	$\frac{1}{2}$ $\frac{1}{2}$	1 $\frac{1}{2}$ 1 $\frac{1}{2}$	1 $\frac{1}{2}$ 1 $\frac{1}{2}$	2 2	2 2	2 2
<b>13.0</b> <b>15.0</b> <b>16.0</b>	13.0 15.0 16.0	78.0 90.0 96.0	$\frac{1}{2}$ $\frac{3}{4}$ 1	1 $\frac{1}{2}$ 2 2	1 $\frac{1}{2}$ 2 2	2 2 2	2 3 3	2 3 3
<b>20.0</b> <b>25.0</b>	20.0 25.0	120.0 150.0	1 $\frac{1}{2}$ 2	3 3	3 3	3 3	3 5	3 5
<b>30.0</b>	30.0	180.0	2	3	3	5	5	5
<b>32.0</b>	32.0	192.0	2	3	5	5	5	5
<b>40.0</b>	40.0	240.0	3	5	7 $\frac{1}{2}$	7 $\frac{1}{2}$	7 $\frac{1}{2}$	7 $\frac{1}{2}$
<b>50.0</b> <b>60.0</b>	50.0 60.0	300.0 360.0	3 5	7 $\frac{1}{2}$ 10	10 10	10 10	10 10	10 15

**Note 1:**

For AC motor circuit nameplate full load current, AC general-use loads, AC resistance loads, AC incandescent lamp (tungsten) loads, AC electric discharge lamp (ballast) loads

**Note 2:**

Conversions per UL508 Table 45.2 and NFPA-70:  
National Electrical Code® 2008 Tables 430-248 and 430-251(A)





File E137938

Ampere rating and horsepower rating 3 phase and 2 phase – 4 wire													
			FLA and LRC ratings converted to table horsepower (see Note 2) use FLA and LRC ratings where no hp rating is listed										
Rated current [A] (see Note 1)	Motor nameplate FLA rating [A]	Motor nameplate Starting/ LCR rating [A]	Nominal circuit voltage										
			110 – 120 VAC		200 VAC		208 VAC		220 – 240 VAC		440 – 480 VAC		
			Motordesign		Motordesign		Motordesign		Motordesign		Motordesign		
			B, C, D [hp]	E [hp]	B, C, D [hp]	E [hp]	B, C, D [hp]	E [hp]	B, C, D [hp]	E [hp]	B, C, D [hp]	E [hp]	
<b>0.30</b>	0.30	3.0											
<b>0.50</b>	0.50	5.0											
<b>0.75</b>	0.75	7.5											
<b>0.80</b>	0.80	8.0											
<b>1.0</b>	1.0	10.0											
<b>1.6</b>	1.6	16.0										1/2	1/2
<b>2.0</b>	2.0	20.0											
<b>2.5</b>	2.5	25.0			1/2	1/2	1/2	1/2	1/2	1/2	1/2	3/4	3/4
<b>3.0</b>	3.0	30.0			1/2	1/2	1/2	1/2	1/2	1/2	1/2	1 1/2	1 1/2
<b>3.5</b>	3.5	35.0			1/2	1/2	3/4	3/4	3/4	3/4	3/4	2	2
<b>4.0</b>	4.0	40.0			3/4	3/4	3/4	3/4	3/4	3/4	3/4	2	2
<b>5.0</b>	5.0	42.0	1/2	1/2	1	1	1	1	1	1	1	3	3
<b>6.0</b>	6.0	50.4	1/2	1/2	1	1	1	1	1 1/2	1 1/2	1 1/2	3	3
<b>8.0</b>	8.0	67.2	3/4	3/4	2	2	2	2	2	2	2	5	5
<b>10.0</b>	10.0	84.0	1	1	2	2	2	2	3	3	3	5	5
<b>12.0</b>	12.0	100.8	1 1/2	1 1/2	3	3	3	3	3	3	3	7 1/2	7 1/2
<b>12.5</b>	12.5	105.0	1 1/2	1 1/2	3	3	3	3	3	3	3	7 1/2	7 1/2
<b>13.0</b>	13.0	109.2	1 1/2	1 1/2	3	3	3	3	3	3	3	7 1/2	7 1/2
<b>15.0</b>	15.0	126.0	2	2	3	3	3	3	3	3	3	10	10
<b>16.0</b>	16.0	134.4	2	2	3	3	3	3	3	5	5	10	10
<b>20.0</b>	20.0	168.0	3	3	5	5	5	5	5	5	5	10	10
<b>25.0</b>	25.0	210.0	3	3	5	5	7 1/2	7 1/2	7 1/2	7 1/2	7 1/2	15	15
<b>30.0</b>	30.0	252.0	5	5	5	5	7 1/2	7 1/2	10	10	10	20	20
<b>32.0</b>	32.0	268.8	5	5	5	5	10	10	10	10	10	20	20
<b>40.0</b>	40.0	226.0	5	5	10	7 1/2	10	7 1/2	10	10	10	30	20
<b>50.0</b>	50.0	282.5	7 1/2	7 1/2	15	10	15	10	15	10	10	30	25
<b>60.0</b>	60.0	339.0	10	10	15	10	20	10	20	15	15	40	30

**Note 1:**  
For AC motor circuit nameplate full load current, AC general-use loads,  
AC resistance loads, AC incandescent lamp (tungsten) loads,  
AC electric discharge lamp (ballast)loads

**Note 2:**  
Conversions per UL508 proposed Tables 45.2 and 45.4 and NFPA-70:  
National Electrical Code® 2008 Tables 430-249, 430-250 and 430-251B)

# Switching Devices Manual Motor Controller

according to UL508 and CSA-22.2 No.14  
Characteristic Product Range UM

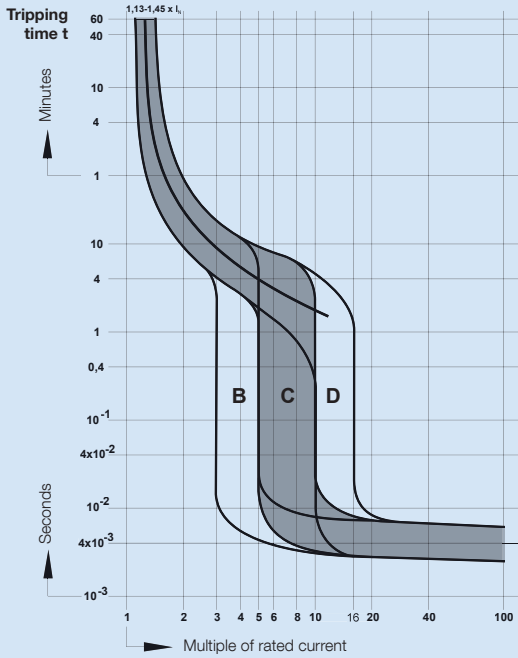

B, C and D characteristic  $I_n = 0.3 - 10 \text{ A}$   
UM

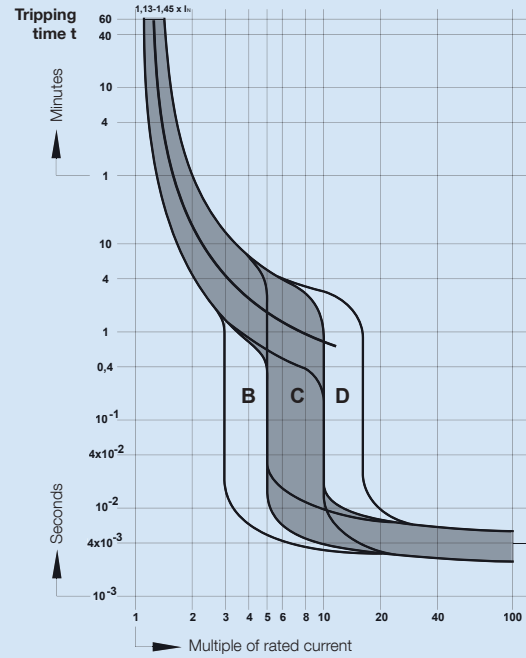

B, C and D characteristic  $I_n = 13 - 63^* \text{ A}$   
UM

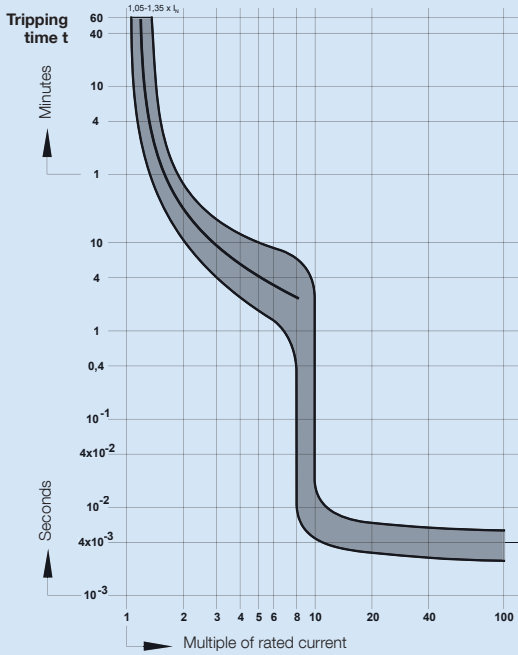

G characteristic  $I_n = 0.3 - 10 \text{ A}$   
UM

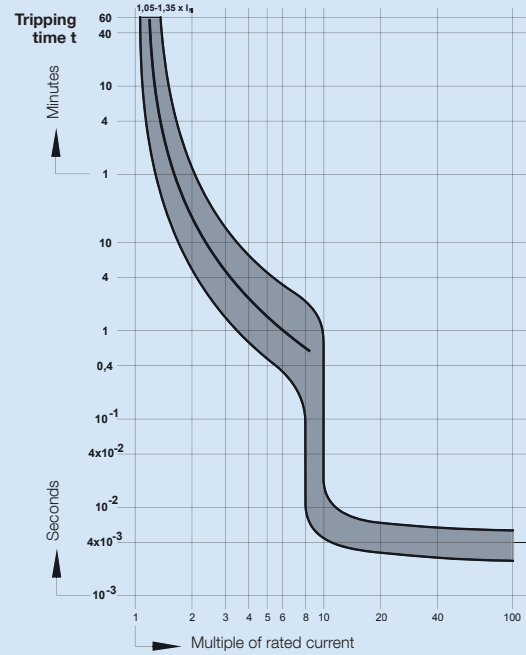

G characteristic  $I_n = 12 - 63^* \text{ A}$   
UM

\* 63 A without UL approval

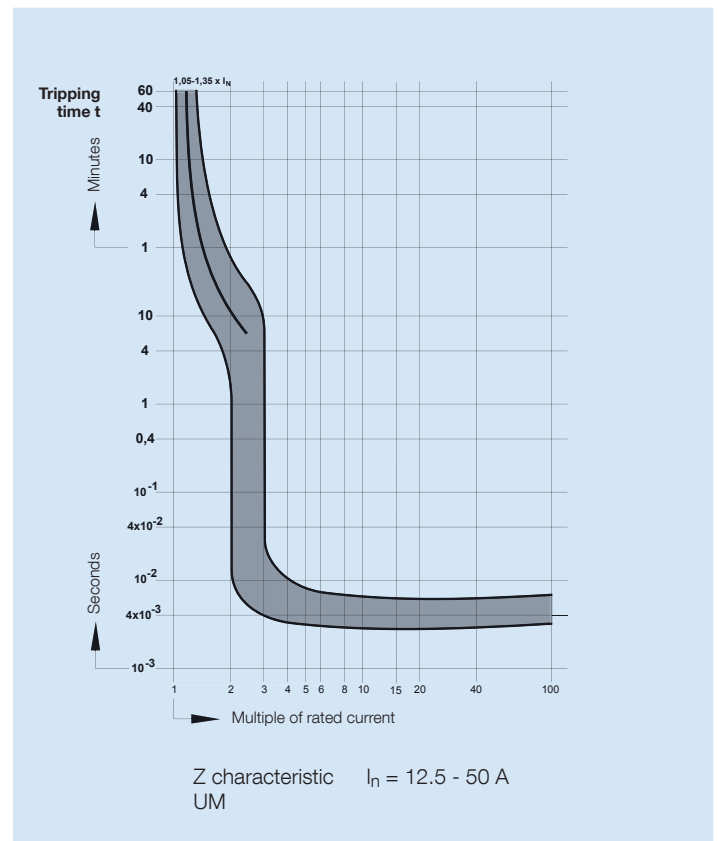
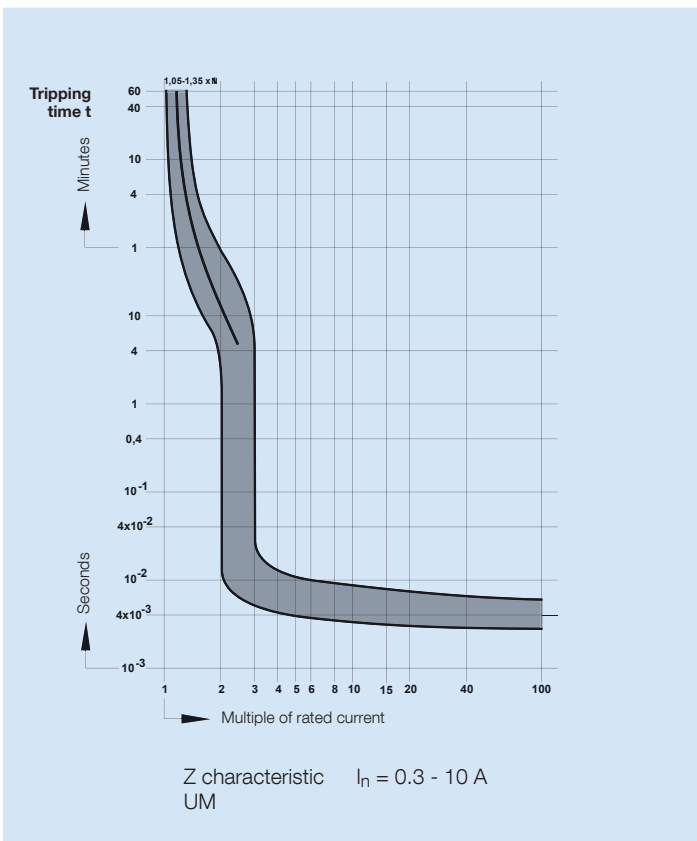
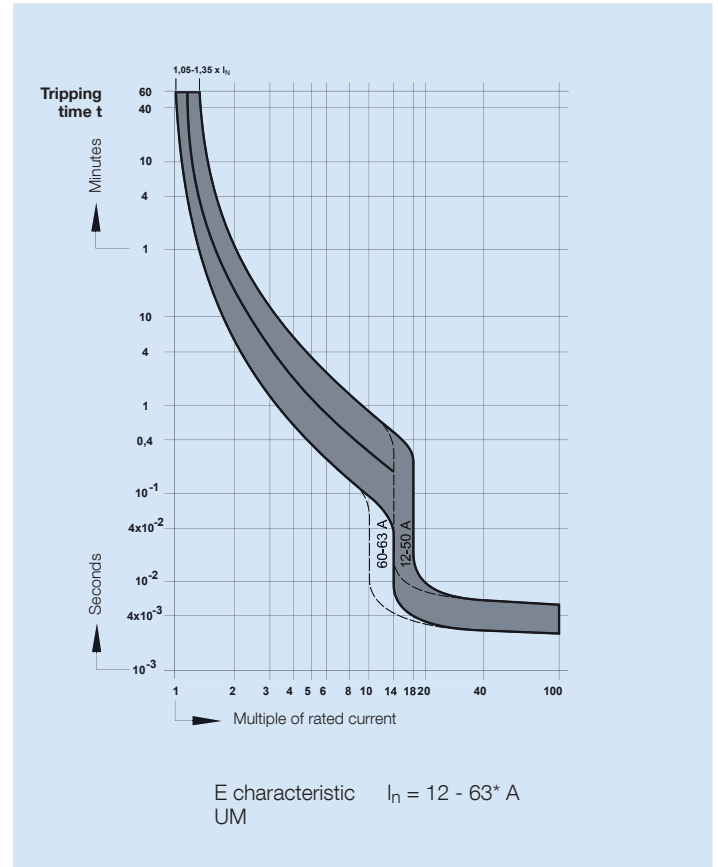
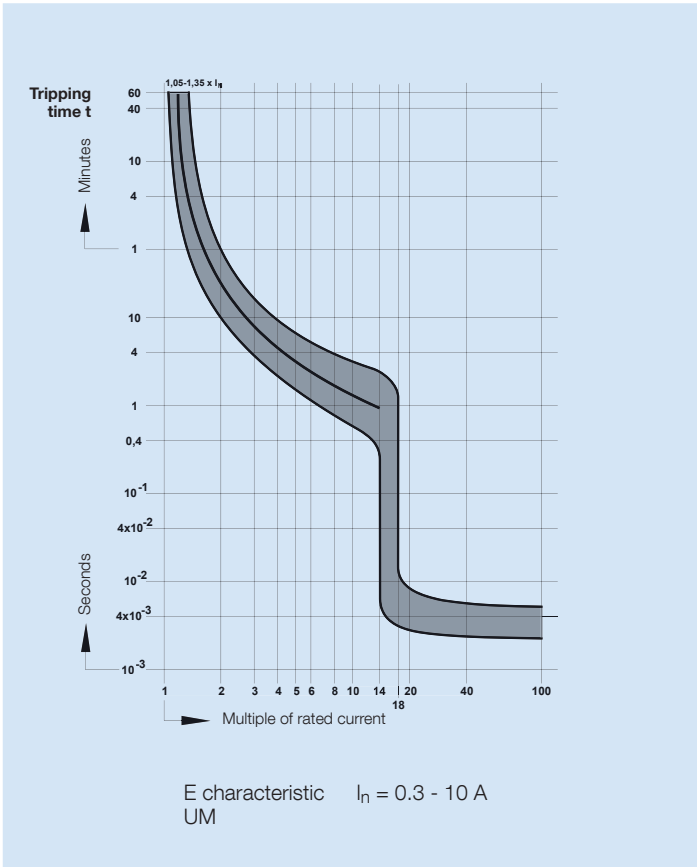

\* 63 A without UL approval



**Extensively tested for practical use –  
ABL SURSUM Switching Devices  
according to UL508 and CSA-22.2 No.14**

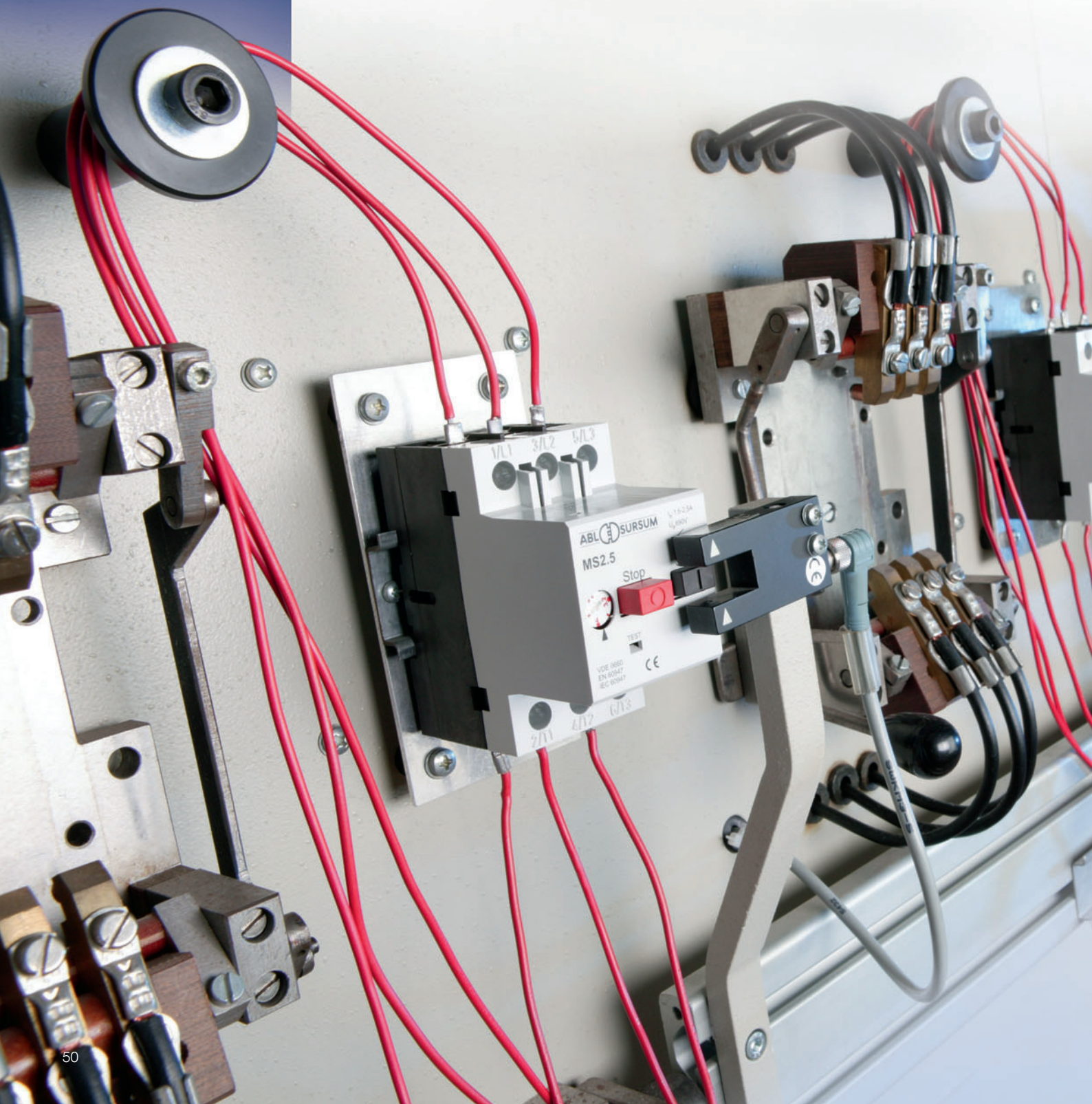



---

**The manual motor starter type MA is a specific development, and combines the design of the miniature circuit breaker with the traditional features of a manual motor controller. The adjustable calibration of the thermal tripping in the IEC nominal rating ranges goes up to 40 A. It was designed to handle high inrush loads from power supplies, motors etc. wiring and equipment can be protected from damages due to overcurrent, and nuisance tripping in cases of high inrush currents can be reduced significantly. With the UL508 approval, this device is available either in an IEC or in a UL approved version.**

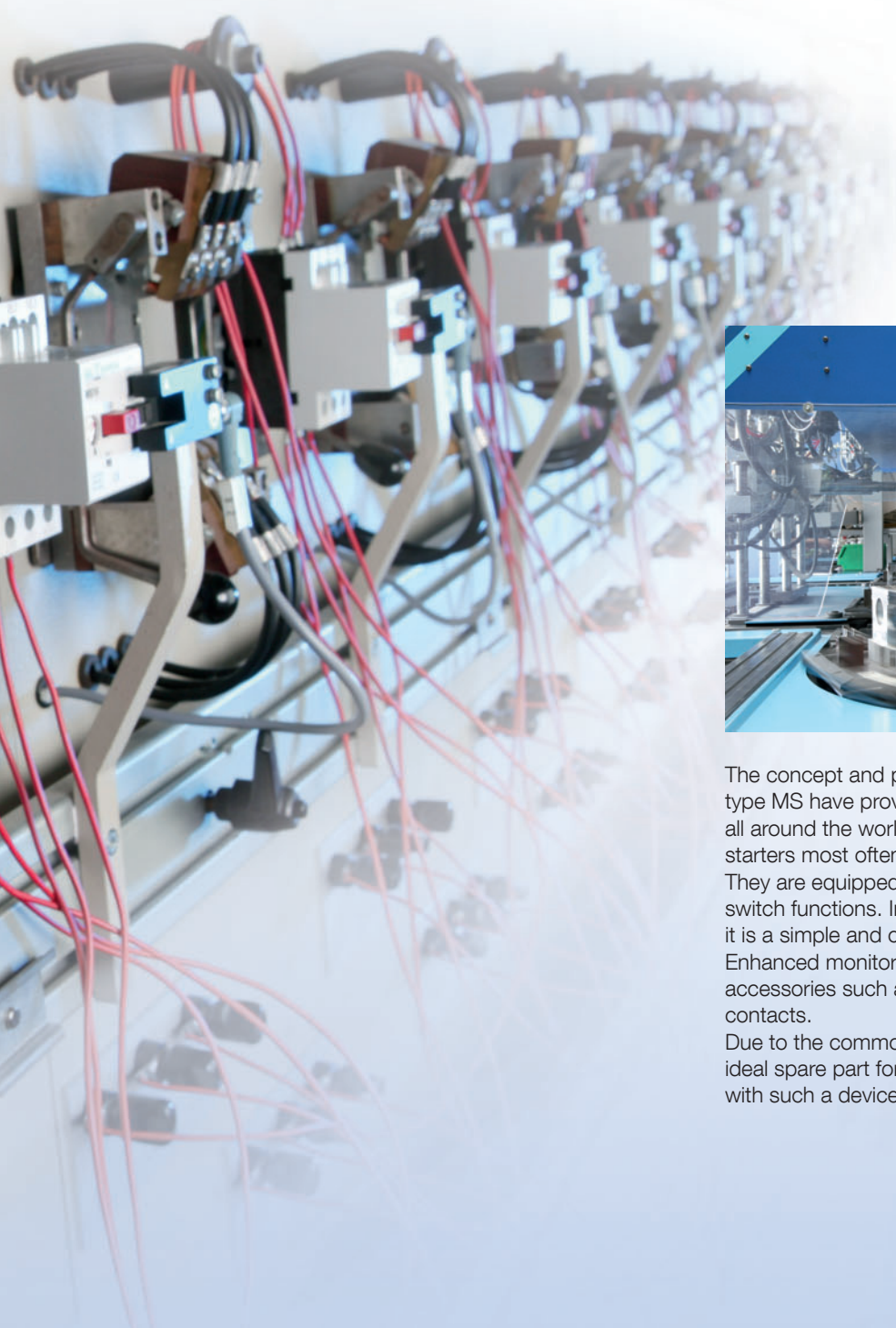

The concept and principles of design of the manual motor starters type MS have proven their reliability through 40 years of experience all around the world. It is still one of the types of manual motor starters most often used in the world for single motor protection. They are equipped with phase failure sensitivity, isolating and main switch functions. In combination with the emergency push button, it is a simple and convenient complete solution for machinery. Enhanced monitoring and control is given with the wide range of accessories such as undervoltage release, shunt trip and auxiliary contacts. Due to the common design and the years of production, it is the ideal spare part for millions of machines which have been equipped with such a device in the past.

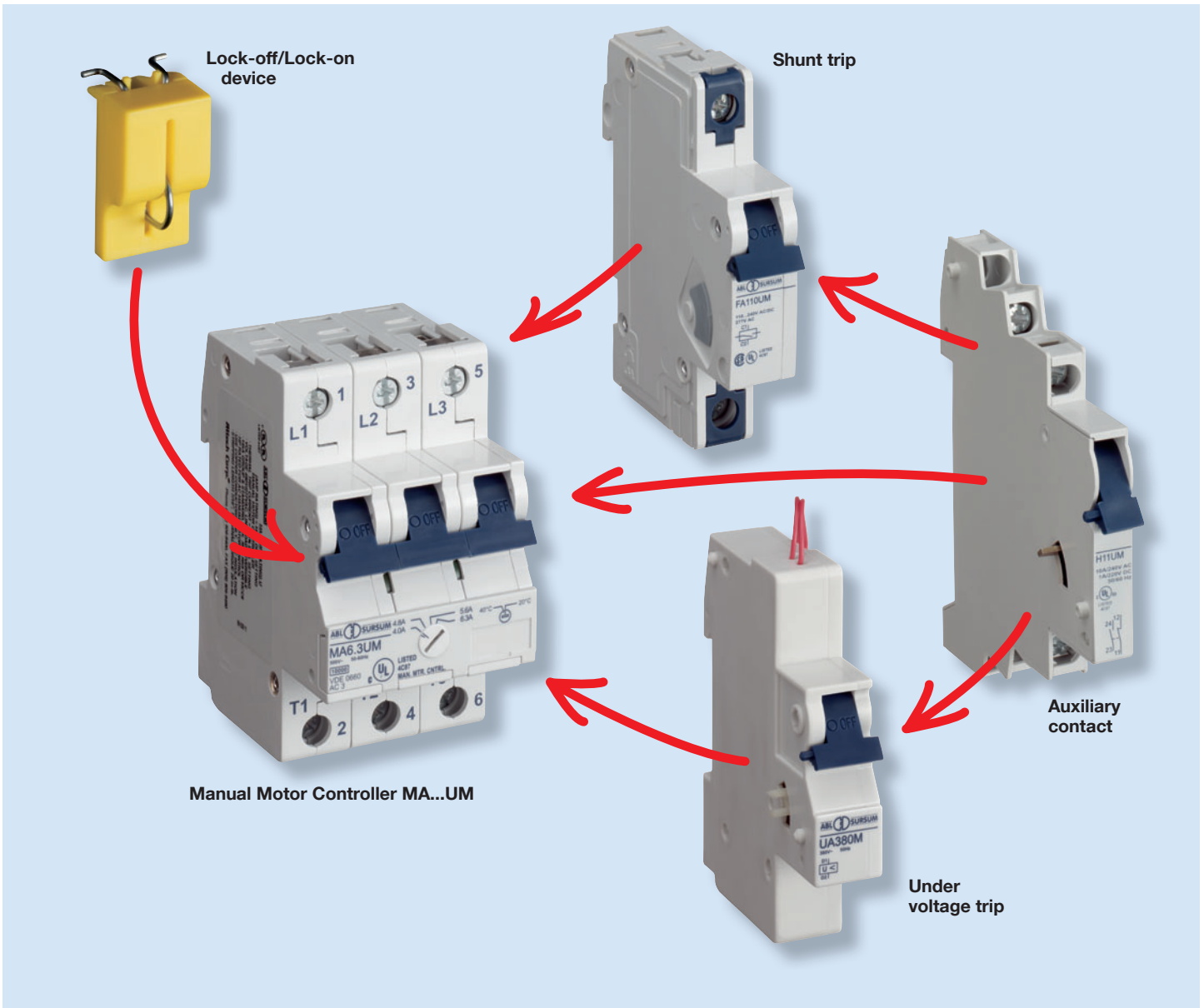

# Switching Devices Manual Motor Controller MA

according to UL508 and CSA-22.2 no. 14  
Product Range MA...UM

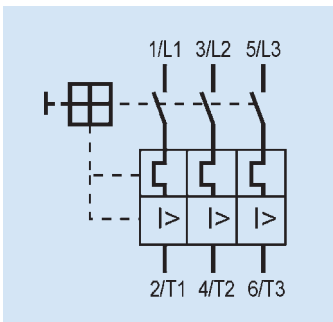

Rated Current [A]	Horsepower ratings at normal line voltage					Operating current short circuit trip [A]	Article no.	Weight g/each	Packing unit
	110-120 V hp (kW)	200V hp (kW)	208 V hp (kW)	220-240 V hp (kW)	460-480 V hp (kW)				
0.1 – 0.16	Through MA2.5UM, ampere rated for motor circuits having a fullload-amperage (FLA) not exceeding the MA's general purpose rated current (RC, equals maximum dial setting) and a lockedrotor current not exceeding 6 times the MA's RC.					1.92	<b>MA016UM</b>	450	1
0.16 – 0.25						3.00	<b>MA025UM</b>	450	1
0.25 – 0.40						4.80	<b>MA040UM</b>	450	1
0.40 – 0.63						7.60	<b>MA063UM</b>	450	1
0.63 – 1.0						12.00	<b>MA1.0UM</b>	450	1
1.0 – 1.6						19.20	<b>MA1.6UM</b>	450	1
1.6 – 2.5						30.00	<b>MA2.5UM</b>	450	1
2.5 – 4.0	½ (0.37)	¾ (0.56)	¾ (0.56)	1 (0.75)	2 (1.5)	48.00	<b>MA4.0UM</b>	450	1
4.0 – 6.3	¾ (0.56)	1½ (1.2)	1½ (1.2)	1 (0.75)	3 (2.24)	75.60	<b>MA6.3UM</b>	450	1
6.3 – 10	1 (0.75)	2 (1.5)	2 (1.5)	3 (2.24)	5 (3.73)	120.00	<b>MA10UM</b>	450	1
10 – 16	2 (1.5)	3 (2.24)	3 (2.24)	5 (3.73)	10 (7.46)	192.00	<b>MA16UM</b>	450	1
16 – 20	3 (2.24)	5 (3.73)	5 (3.73)	5 (3.73)	10 (7.46)	240.00	<b>MA20UM</b>	450	1
20 – 25	3 (2.24)	5 (3.73)	7½ (5.6)	7½ (5.6)	15 (11.19)	300.00	<b>MA25UM</b>	450	1
25 – 32	5 (3.73)	7½ (5.6)	7½ (5.6)	10 (7.46)	20 (14.92)	240.00	<b>MA32UM</b>	450	1
32 – 40	5 (3.73)	10 (7.46)	10 (7.46)	10 (7.46)	25 (18.65)	300.00	<b>MA40UM</b>	450	1

# Accessories for Switching Devices Manual Motor Controller MA

according to UL508 and CSA-22.2 No.14  
for Product Ranges UM and MA...UM



Shunt trip					
Module	Rated operating voltage	Max. operating current at $U_n$ ( $t < 10$ ms)	Article no.	Weight g/each	Packing unit
1	12 V $\approx$	1.3 A	<b>FA12UM</b>	105	5
1	24 V $\approx$	0.6 A	<b>FA24UM</b>	105	5
1	48 - 72 V $\approx$	0.2 A	<b>FA48UM</b>	105	5
1	110 - 240 V $\approx$ , 415 V~	0.25 A at 110 V 0.5 A at 240 V 0.58 A at 277 V	<b>FA110UM</b>	105	5
Pull-in voltage $0.7 \times U_e$			Switch in duration for $U_e$ 100%		



Undervoltage trip (60 Hz) *					
Module	Rated voltage		Article no.	Weight g/each	Packing unit
1	120 V		<b>UA120UM</b>	150	5
1	220 V		<b>UA220UM</b>	150	5
Pull-in voltage $\geq 0.85 \times U_e$		Drop out voltage $0.35 - 0.7 \times U_e$		Switch in duration for $U_e$ 100%	

\* without UL approval



Auxiliary contact					
Module	Type of contact	Contacts	Article no.	Weight g/each	Packing unit
1/2	1 auxiliary contact	1NO	<b>H10UM</b>	35	10
1/2	2 auxiliary contacts	1NO + 1NC	<b>H11UM</b>	40	10
1/2	3 auxiliary contacts	1NO + 2NC	<b>H12UM</b>	45	10
1/2	3 auxiliary contacts	2NO + 1NC	<b>H21UM</b>	45	10

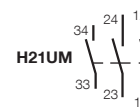
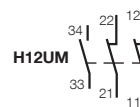
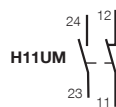

Standards	according to IEC 60947-5-1, DIN EN 60947-5-1, VDE 0660-200, UL508
Rated operating currents	10 A / 240 V AC 3 A / 110 V DC 1 A / 220 V DC
Minimum contact load	1 mA at 24 V DC

Conductor cross sections		
Type of conductor *)	min.	max.
Single wire	1.0 mm <sup>2</sup> (AWG18)	2.5 mm <sup>2</sup> (AWG14)
Stranded wire	1.0 mm <sup>2</sup> (AWG18)	1.5 mm <sup>2</sup> (AWG16)
Stranded wire with ferrule	1.0 mm <sup>2</sup> (AWG18)	1.5 mm <sup>2</sup> (AWG16)
Torque	max. 0.8 Nm (7 lb.in)	

\*) Stripped length 8 - 9 mm

# Accessories for Switching Devices Manual Motor Controller MA

according to UL508 and CSA-22.2 No.14  
for Product Ranges UM and MA...UM

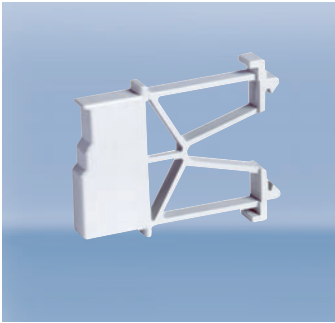

**Distance device 9 mm**

Module	Article no.	Weight g/each	Packing unit
1/2	HDS	7	10



**Lock-off/Lock-on device**

For miniature circuit breakers  
and motor protective circuit  
breakers

Article no.	Weight g/each	Packing unit
<b>EASS</b>	4	10

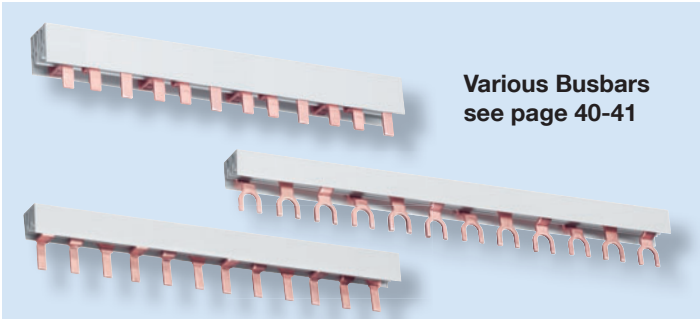

**Various Busbars  
see page 40-41**



Technical Data		
Standards	UL508 and CSA-22.2 No.14	
Short circuit withstand rating	0.16 A – 2.5 A / 42 kA, 4 A – 16 A / 14 kA, 20 – 40 A / 10 kA	
Utilization category	AC 3 at $U_e$ 415 V~ (up to $I_n$ 25 A)	
Group Short Circuit Ratings (UL/CSA Ratings)	1200 A / 42 kA, 350 A / 14 kA, 350 A / 10 kA	
Rated voltage AC	480Y / 277 VAC	
Rated current range	15 setting ranges from 0.1 up to 40 A	
Rated uninterrupted current $I_{th}$	40 A	
Tripping time at $6 \times I_e$	> 5s/TII	
Test currents	Thermal not tripping $I_1$ (A) > 2 h	$1.05 \times I_e$
	Thermal tripping $I_2$ (A) < 2 h	$1.15 \times I_e$
	Electromagnetic not tripping $I_4$ (A) > 0.1 s	for the lower setting $16 \times I_e$ ( $12.5 \times I_e > 16$ A) for the upper setting $10 \times I_e$
	Electromagnetic tripping $I_5$ (A) < 0.1 s	for the lower setting $19 \times I_e$ ( $15 \times I_e > 16$ A) for the upper setting $12 \times I_e$
Temperature compensation	up to +40 °C	
Permitted ambient temperature	open -20 °C to +50 °C, enclosure -20 °C to +40 °C storage/transport -40 °C to +70 °C	
Device depth according to DIN 43880	68 mm	
Mechanical endurance	30 000 switching cycles (30 000 ON / 30 000 OFF)	
Permitted operating frequency	30 switching cycles/h	
Protection cover	Safe for fingers and back of hand acc. to DIN EN 50274, VDE 0660-514 BGV A2	
Degree of protection according to EN/IEC 60529	IP20	
Installation position	any	
Mounting	On DIN-rail acc. to DIN EN 60715 35 mm	
Lockability	The handle can be secured against manual switching in the on and off position by a lead seal	
Climatic resistance	Humid heat constant according to DIN IEC 60068-2 – 78 Humid heat cyclic according to DIN EN 60068-2 – 30	
Vibration resistance	> 15 g according to DIN EN 60068-2 – 59 for a load with $I_1$	
Resistance to mechanical shocks	25 g 11 ms	

Conductor cross sections				
Type of conductor *)	Box terminal bottom		Box terminal top	
	max.	min.	max.	min.
Single wire	25 mm <sup>2</sup> (AWG3)	1.0 mm <sup>2</sup> (AWG18)	25 mm <sup>2</sup> (AWG3)	1.0 mm <sup>2</sup> (AWG18)
Multiple wire	25 mm <sup>2</sup> (AWG3)	16 mm <sup>2</sup> (AWG6)	25 mm <sup>2</sup> (AWG3)	16 mm <sup>2</sup> (AWG6)
Stranded wire	16 mm <sup>2</sup> (AWG6)	1.0 mm <sup>2</sup> (AWG18)	25 mm <sup>2</sup> (AWG3)	1.0 mm <sup>2</sup> (AWG18)
Stranded wire with ferrule	16 mm <sup>2</sup> (AWG6)	1.0 mm <sup>2</sup> (AWG18)	16 mm <sup>2</sup> (AWG6)	1.0 mm <sup>2</sup> (AWG18)
Busbar Cable lug	up to 3 mm thickness		up to 1.5 mm thickness	
Combined, conductor and busbar or cable lug	up to 25 mm <sup>2</sup> and up to 2 mm thickness		not possible	
Torque	max. 2.5 Nm (22.2 lb.in)			

\*) Stripped length: bottom 12 - 14 mm, top 10 - 12 mm

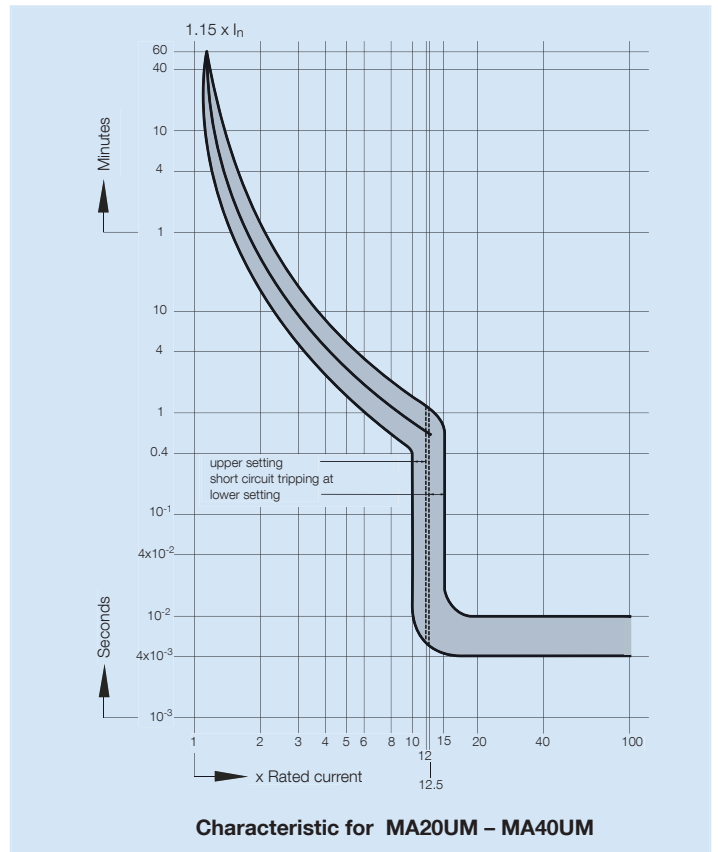
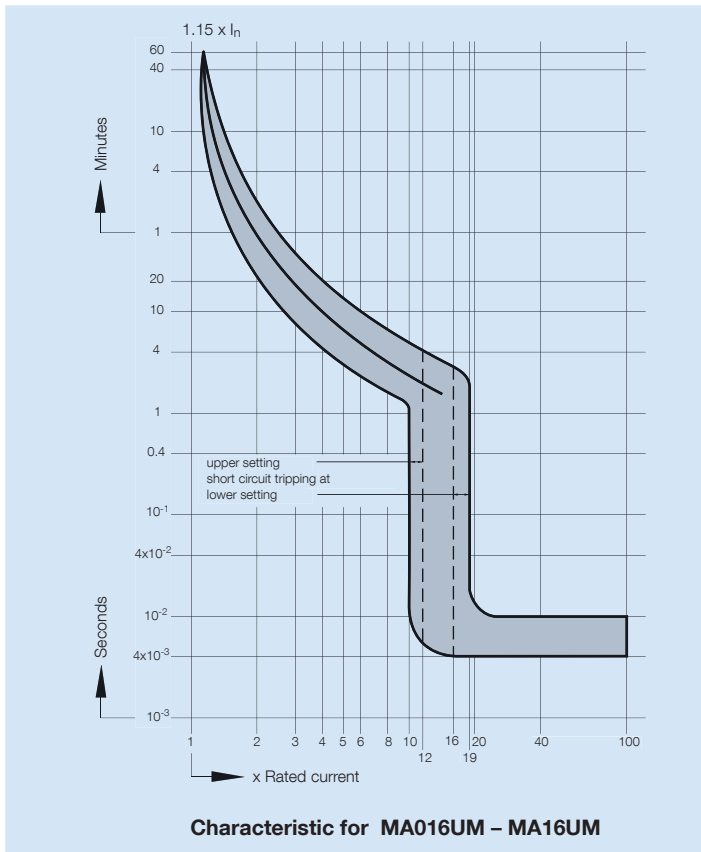

Internal resistance per pole in mΩ and power loss in Watt of the complete device					
Type	Lower setting	Upper setting	Internal resistance per pole mΩ	Power loss for the complete device for	
	A	A		lower setting Watt	upper setting Watt
MA016UM	0.10	0.16	85500	2.6	6.6
MA025UM	0.16	0.25	35000	2.7	6.6
MA040UM	0.25	0.40	15000	2.8	7.2
MA063UM	0.40	0.63	5200	2.5	6.2
MA1.0UM	0.63	1.0	2300	2.7	6.9
MA1.6UM	1.0	1.6	950	2.9	7.3
MA2.5UM	1.6	2.5	355	2.7	6.7
MA4.0UM	2.5	4.0	142	2.7	6.8
MA6.3UM	4.0	6.3	54	2.6	6.4
MA.10UM	6.3	10	28	3.3	8.4
MA.16UM	10	16	13.9	4.2	10.7
MA.20UM	16	20	9.9	5.2	8.2
MA.25UM	20	25	6.3	8	12.3
MA.32UM	25	32	3.85	6.4	10.5
MA.40UM	32	40	3.1	8.6	13.4

Type	Rated Current [A]	FLA Dial Adjustment Markings	Group short circuit rating at 480 VAC <sup>a)</sup> (and BCP size)	3 Ø horsepower ratings at nominal line voltage (see note for HEA definition)				
				110 – 120 V hp (HEA)	200 V hp (HEA)	208 V hp (HEA)	220 – 240 V hp (HEA)	460 – 480 V hp (HEA)
MA016UM	0.16	0.1/ 0.12/0.14/0.16	42 kARMS symmetrical (max. 1200 A MCCB or RK5)	Through MA2.5UM, ampere rated for motor circuits having a fullload-amperage (FLA) not exceeding the MA's general purpose rated current (RC, equals maximum dial setting) and a lockedrotor current not exceeding 6 times the MA's RC.				
MA025UM	0.25	0.16/0.19/0.22/0.25						
MA040UM	0.40	0.25/0.30/0.35/0.40						
MA063UM	0.63	0.40/0.48/0.56/0.63						
MA1.0UM	1.00	0.63/0.75/0.87/1.0						
MA1.6UM	1.60	1.0/1.2/1.4/1.6						
MA2.5UM	2.50	1.6/1.9/2.2/2.5						
MA4.0UM	4.00	2.5/3.0/3.5/4.0	14 kARMS symmetrical (max. 350 A MCCB or RK5)	½ (4.0)	¾ (3.2)	¾ (3.1)	1 (3.6)	2 (3.42)
MA6.3UM	6.30	4.0/4.8/5.6/6.3		¾ (5.6)	1½ (6.0)	1½ (5.7)	1½ (5.2)	3 (4.8)
MA10UM	10	6.3/7.5/8.7/10		1 (7.2)	2 (7.8)	2 (7.5)	3 (9.6)	5 (7.6)
MA16UM	16	10/12/14/16		2 (13.6)	3 (11.0)	3 (10.6)	5 (15.2)	10 (14.0)
MA20UM	20	16/17/18.5/20	10 kARMS symmetrical (max. 350 A MCCB or RK5)	3 (19.2)	5 (17.5)	5 (16.7)	5 (15.2)	10 (14.0)
MA25UM	25	20/21.5/23/25		3 (19.2)	5 (17.5)	7½ (24.2)	7½ (22.0)	15 (21.0)
MA32UM	32	25/27/30/32		5 (30.4)	7½ (25.0)	7½ (24.2)	10 (28.0)	20 (27.0)
MA40UM	40	32/34/37/40		5 (30.4)	10 (32.0)	10 (31.0)	10 (28.0)	25 (34.0)

**Note:**  
 HEA - Horsepower Equivalent Amperes, the nominal amperage assigned to standard motor horsepower ratings in design guide tables such as NFPA-70 Tables 430-248, 430-249, 430-250; UL1077 Table 16.2; CSA - C22.2 No. 235-M89 Tables 44 and 45; CSA-C22.2 No. 14-M91 Table 19, etc.  
 Multiply HEA values (in parenthesis) by 1.1 if power factor is 90%, and by 1.2 if power factor is 80%.

a) The standard-circuit short-circuit rating is 14 kA for all types. Group ratings can be used in a standard circuit (e.g., MA1.0UM at 42 kA), but a higher standard rating cannot be used in a group circuit (e.g., MA40UM at 14 kA only in standard circuit.)

# Switching Devices Manual Motor Controller MA

according to UL508 and CSA-22.2 No.14  
Dimension Drawing

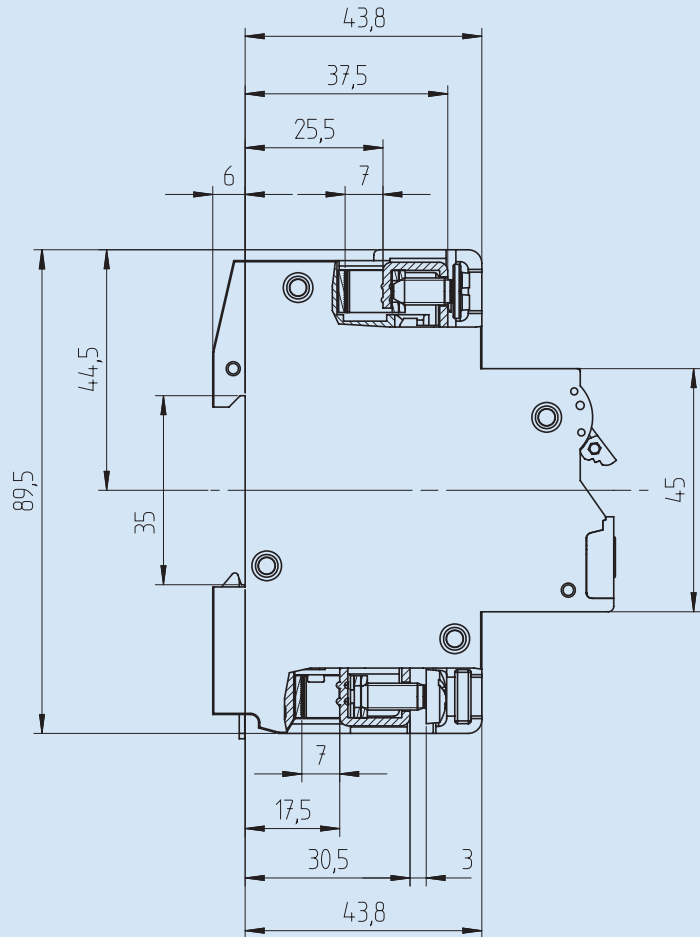
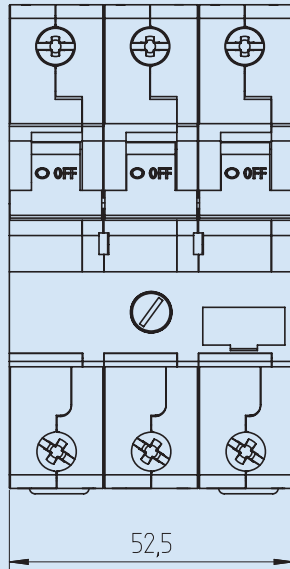

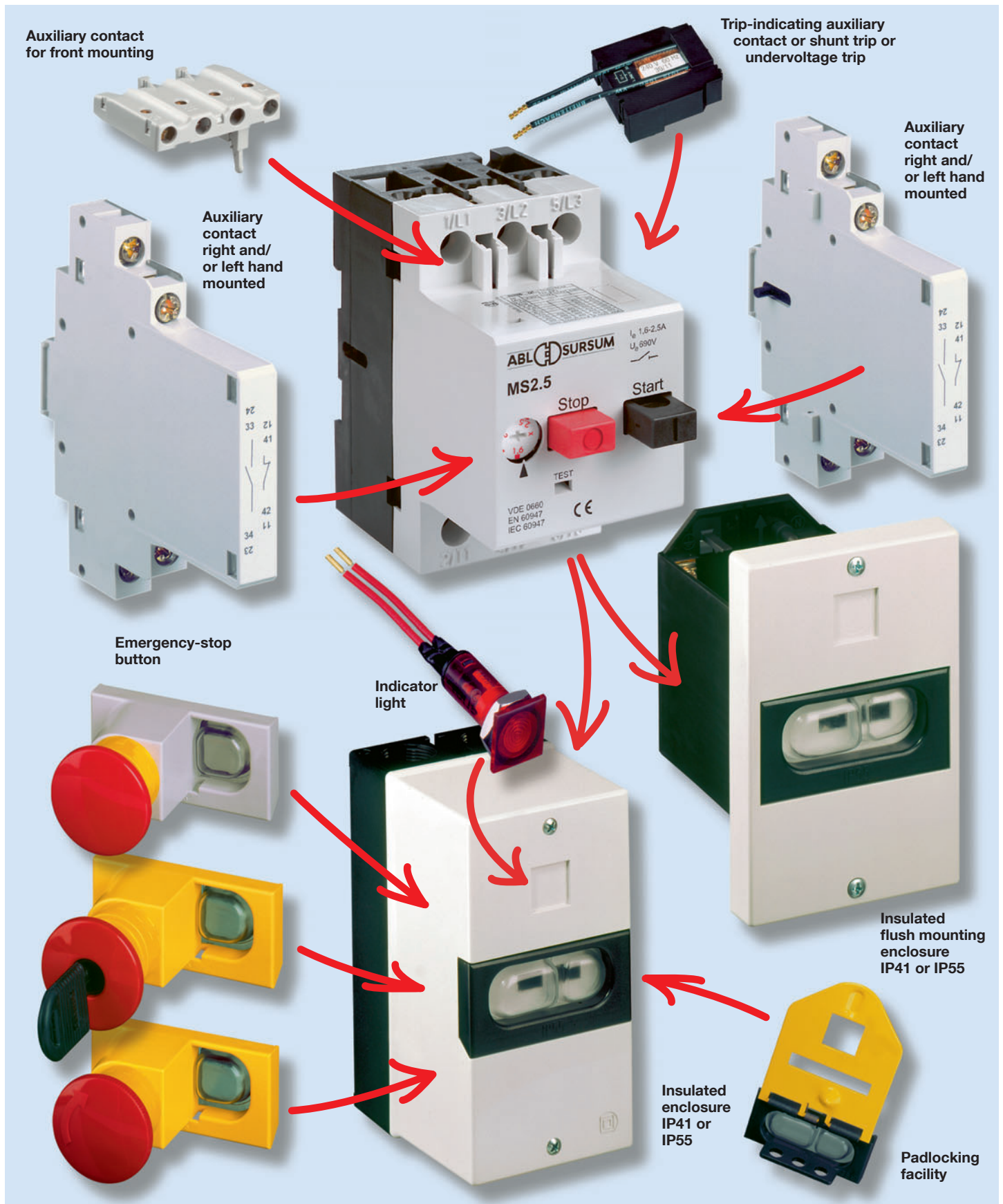



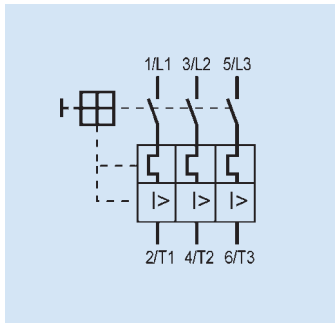

Rated Current [A]	Horsepower ratings at nominal line voltage					Operating current short circuit trip [A]	Article no.	Weight g/each	Packing unit
	115V hp (kW)	200V hp (kW)	230V hp (kW)	480V hp (kW)	600 hp (kW)				
0.1 - 0.16	Ampere rated for motor circuits having a full-load-amperage (FLA) not exceeding the MS's general purpose rated current and a locked rotor current not exceeding 6 times the MS's rated current.					1.92	<b>MS016</b>	250	1
0.16 - 0.25						3.00	<b>MS025</b>	250	1
0.25 - 0.40						4.80	<b>MS040</b>	250	1
0.40 - 0.63						7.60	<b>MS063</b>	250	1
0.63 - 1.0						12.00	<b>MS1</b>	250	1
1.0 - 1.6						19.20	<b>MS1.6</b>	250	1
1.6 - 2.5						30.00	<b>MS2.5</b>	250	1
2.5 - 4.0	1/2 (0.37)	3/4 (0.56)	1 (0.75)	2 (1.5)	3 (2.24)	48.00	<b>MS4</b>	250	1
4.0 - 6.3	3/4 (0.56)	1 1/2 (1.2)	1 (0.75)	3 (2.24)	5 (3.73)	75.60	<b>MS6.3</b>	250	1
6.3 - 10	1 (0.75)	2 (1.5)	3 (2.24)	5 (3.73)	7 1/2 (5.6)	120.00	<b>MS10</b>	250	1
10 - 16	2 (1.5)	3 (2.24)	5 (3.73)	10 (7.46)	10 (7.46)	192.00	<b>MS16</b>	250	1
16 - 20	3 (2.24)	5 (3.73)	5 (3.73)	10 (7.46)	-	240.00	<b>MS20</b>	250	1
20 - 25	3 (2.24)	5 (3.73)	7 1/2 (5.6)	15 (11.19)	-	300.00	<b>MS25</b>	250	1

Modules	Wiring diagram	Contacts	Article no.	Weight g/each	Packing unit
---------	----------------	----------	-------------	---------------	--------------



Auxiliary contact for side mounting					
1/2 M		2 NO	<b>HMS20</b>	40	5
1/2 M		1 NO + 1 NC	<b>HMS11</b>	40	5
1/2 M		1 NO	<b>HMS10</b>	40	5
1/2 M		2 NC	<b>HMS02</b>	40	5
1/2 M		1 NC	<b>HMS01</b>	40	5



Early make auxiliary contact for side mounting					
1/2 M		1 NO + 1 NC	<b>VHMS11</b>	40	5
1/2 M		2 NO	<b>VHMS20</b>	40	5

Technical Data	HMS, VHMS
Rated impulse withstand voltage $U_{imp}$	4 000 V
Rated operating voltage $U_e$	500 V
Overvoltage category/Pollution level	III/3
Max. current (with free air circulation) $I_{th}$	6A
Rated operating current $I_e$	3.5/2 A
Can also be used for low voltage and PLC-inputs	24 V DC, 10 mA
Cross section: 1 conductor mm <sup>2</sup> 2 conductor mm <sup>2</sup> only HMS, VHMS	0.75 – 2.5 r; 0.75 – 1.5 f (with ferrule) 0.75 – 2.5 r; 0.75 – 1.5 f (with ferrule)

	Rated operating voltage	Article no.	Weight g/each	Packing unit
--	-------------------------	-------------	---------------	--------------

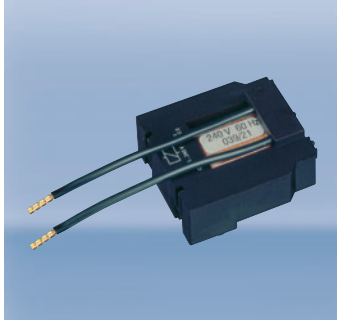

<b>Shunt trip for inside mounting with connecting cable (140 mm long)</b>				
	110 V 50 Hz, 120 V 60 Hz	<b>AMS110</b>	75	10
	220-230V 50 Hz, 240 V 60 Hz	<b>AMS220</b>	75	10
	380-415 V 50 Hz, 440 V 60 Hz	<b>AMS380</b>	75	10
	24 V 50/60 Hz	<b>AMS24</b>	75	10
	500 V 50 Hz	<b>AMS500</b>	75	10
	24 V DC	<b>AMSD24</b>	75	10
Pull-in voltage $0.7 \times U_e$			Switch in duration for $U_e$ 100 % AC	

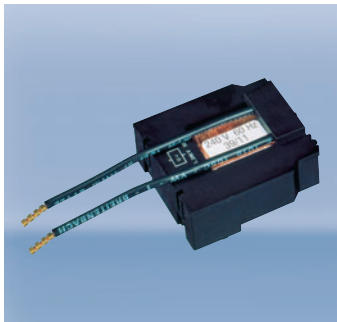
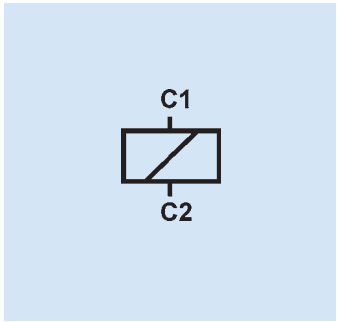

<b>Undervoltage trip for inside mounting with connecting cable (140 mm long)</b>				
	110 V 50 Hz, 120 V 60 Hz	<b>UMS110</b>	75	10
	220-230 V 50 Hz, 240 V 60 Hz	<b>UMS220</b>	75	10
	380-415 V 50 Hz, 440 V 60 Hz	<b>UMS380</b>	75	10
	24 V 50/60 Hz	<b>UMS24</b>	75	10
	500 V 50 Hz	<b>UMS500</b>	75	10
Pull-in voltage $\geq 0.85 \times U_e$		Drop out voltage $0.35-0.7 \times U_e$		Switch in duration for $U_e$ 100%

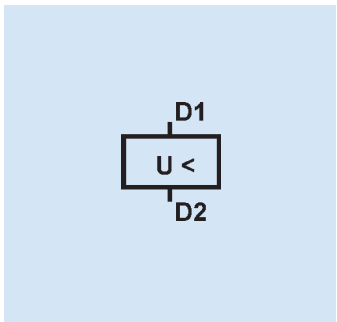



**Insulated enclosure IP55**  
with integrated PE(N) terminal  
top and bottom each 2 metric  
knock-outs

	Article no.	Weight g/each	Packing unit
	<b>MS.G55</b>	240	1



**Insulated flush mounting enclosure IP55**  
with integrated PE(N) terminal

	Article no.	Weight g/each	Packing unit
	<b>MS.F55</b>	170	1

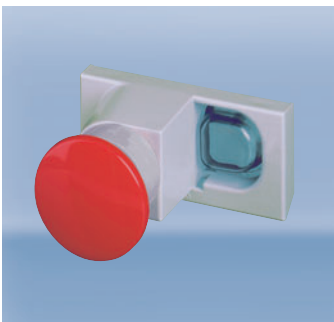

**Stop button**  
not latching  
red, on grey surface

	Article no.	Weight g/each	Packing unit
	<b>MS.PT</b>	55	5



**Padlocking facility**  
for up to three padlocks

	Article no.	Weight g/each	Packing unit
	<b>MS.VS</b>	100	10

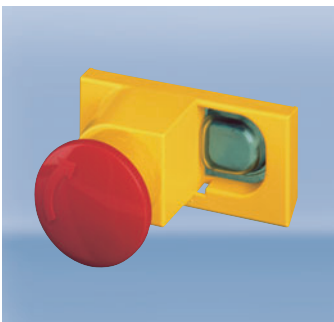

**Emergency-stop button**  
latching,  
turn to release  
red, on yellow surface

	Article no.	Weight g/each	Packing unit
	<b>MS.PV</b>	60	5

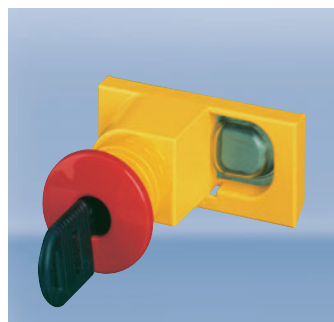

**Emergency-stop button**  
latching,  
key release (2 keys)  
red, on yellow surface

	Article no.	Weight g/each	Packing unit
	<b>MS.PS2</b>	65	5



**Indicator light**  
with glow bulb,  
nominal rated voltage: 220-240 V

Colour	Article no.	Weight g/each	Packing unit
transp.	<b>MS.SLW2</b>	10	5
green	<b>MS.SLG2</b>	10	5
red	<b>MS.SLR2</b>	10	5
yellow	<b>MS.SLJ2</b>	10	5



**Indicator light**  
with glow bulb,  
nominal rated voltage: 380-440 V

Colour	Article no.	Weight g/each	Packing unit
transp.	<b>MS.SLW3</b>	10	5
green	<b>MS.SLG3</b>	10	5
red	<b>MS.SLR3</b>	10	5
yellow	<b>MS.SLJ3</b>	10	5

Description	max. busbar current (A)	Length	Article no.	Weight g/each	Packing unit
-------------	-------------------------	--------	-------------	---------------	--------------

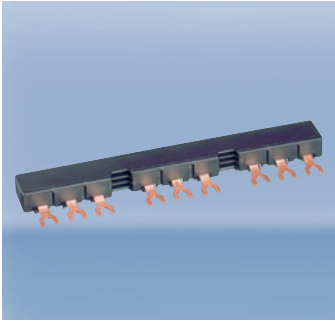

<b>Busbars</b>					
for 2 MPCBs without auxiliary contacts	63	90 mm	<b>SB.D02</b>	37	10
for 3 MPCBs without auxiliary contacts	63	136 mm	<b>SB.D03</b>	55	10
for 4 MPCBs without auxiliary contacts	63	180 mm	<b>SB.D04</b>	75	10
for 2 MPCBs each with 1 auxiliary contact fitted on the right side	63	99 mm	<b>SB.D12</b>	40	10
for 3 MPCBs each with 1 auxiliary contact fitted on the right side	63	153 mm	<b>SB.D13</b>	65	10
for 4 MPCBs each with 1 auxiliary contact fitted on the right side	63	207 mm	<b>SB.D14</b>	90	10
for 5 MPCBs each with 1 auxiliary contact fitted on the right side	63	261 mm	<b>SB.D15</b>	115	10
for 2 MPCBs each with 2 auxiliary contacts	63	108 mm	<b>SB.D22</b>	45	10
for 4 MPCBs each with 2 auxiliary contacts	63	234 mm	<b>SB.D24</b>	105	10

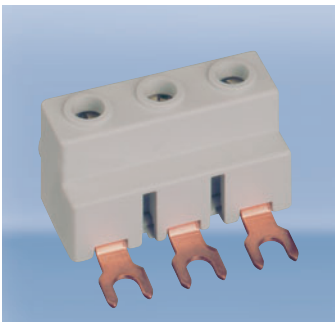

<b>Incoming terminal block</b>					
	63		<b>SB.DE1</b>	30	10



<b>Shroud</b>					
			<b>SB.DA1</b>	5	10





File E 137938

Standards	IEC 60947, DIN EN 60947, VDE 0660
Mechanical endurance = Electrical endurance	0.1 x 10 <sup>6</sup> switching cycles
Max. operating frequency	30 switching cycles / h
Ambient temperature not enclosed, max./min. enclosed, max./min.	+55 °C / -20 °C +40 °C / -20 °C
Resistance to mechanical shocks	15 g / 10 ms
Installation position	any, in IP41 enclosure vertical
Cross section (1 or 2 conductors)	1.0 – 6 r; 0.75 – 4 f (with ferrule) 2 conductors differing by not more than 2 sizes
Torque for terminal screws - Main conductor - Auxiliary conductor - Auxiliary contact for front mounting	1.2 Nm 1.0 Nm 0.5 Nm
Rated impulse withstand voltage U <sub>imp</sub>	6 000 V
Overvoltage category / Pollution level	III / 3
Rated operating voltage U <sub>e</sub>	690 V AC
Rated operating current I <sub>e</sub>	0.16 – 25 A according to setting range
Frequency	40...60 Hz
	At higher frequencies, the electromagnetic tripping values rise by a factor of about 1.1 at 100 Hz; 1.2 at 200 Hz; 1.4 at 400 Hz; 1.5 at 500 Hz
Utilization category (IEC 60947-4-1, DIN EN 60947-4-1, VDE 0660-102)	AC-3 max. 690 V
Temperature compensation (reference values to VDE / IEC)	-5 °C / +40 °C
Temperature compensation Operating range	-20 °C...+55 °C
Power loss in watt per path of current	by min. setting range 0.6 – 1.05 W / by max. setting range 1.5 – 2.6 W

Rated short circuit withstand rating I <sub>cu</sub> MS IEC 60947-2, DIN EN 60947-2, VDE 0660-101	
Upper setting Thermal tripping	I <sub>cu</sub> (kA)
	230 V      400 V      500 V      690 V
0.16 – 1.6 A	No additional protective devices needed inherently stable for any selected short circuit currents
2.5 – 6.3 A	3      2.5
10 A	6      3      2.5
16 – 25 A	10      6      2.5      2

**Switching times at short circuit**

minimum command time	2 ms
opening delay	2 ms
opening time	7 ms



UL and CSA Rating					EN and IEC Rating			
Type	Fuse [A]	Group Fusing [A]	Voltage [V]	Interrupting Capacity [kA]	Back-up fuse (gL, aM) [A]			
					230 V	400 V	500 V	690 V
MS016	1	100	600	5	No back-up fuse necessary inherently stable for any selected short circuit currents			
MS025	1	100	600	5				
MS040	1	100	600	5				
MS063	2	100	600	5				
MS1	4	100	600	5				
MS1.6	6	100	600	5				
MS2.5	10	100	600	5				
MS4	15	100	600	5				
MS6.3	25	50	600	5				
MS10	40		600	5				
MS16	60		600	5	80	80	63	35
MS20	60		480	5	80	80	63	50
MS25	70		480	5	80	80	63	50

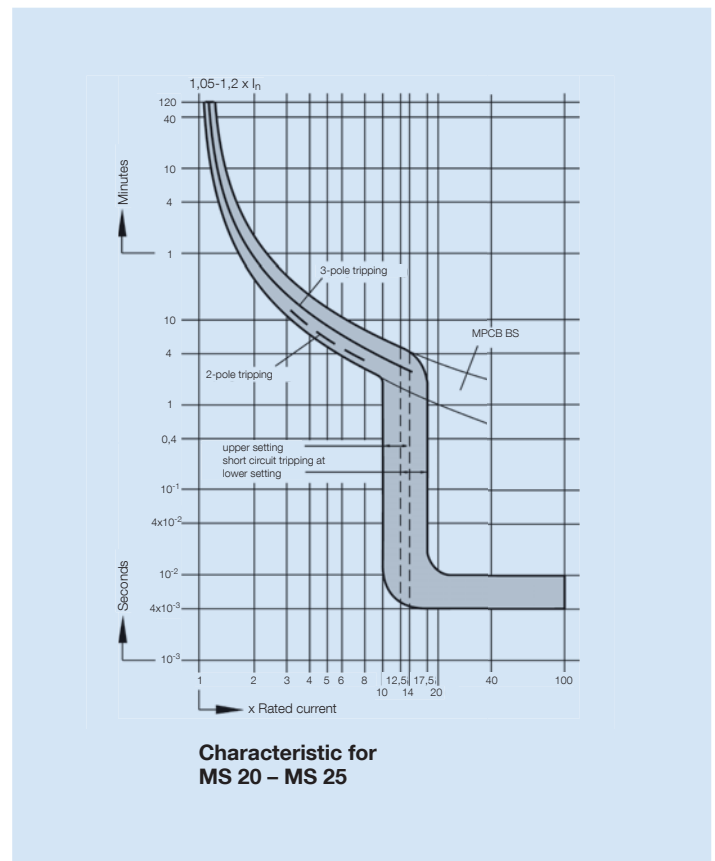
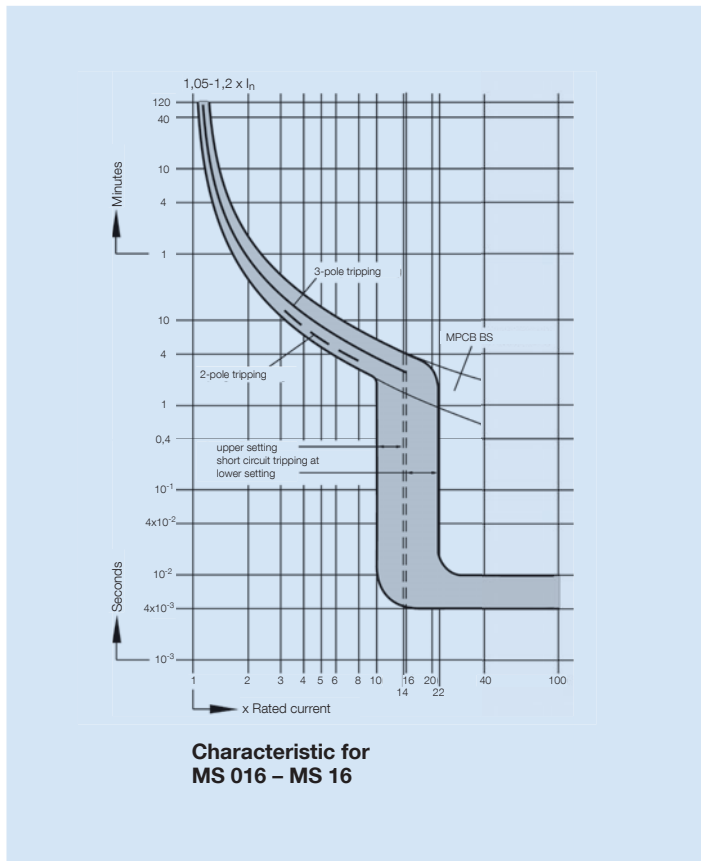

### Motor protective circuit breaker MS

Mounting dimensions

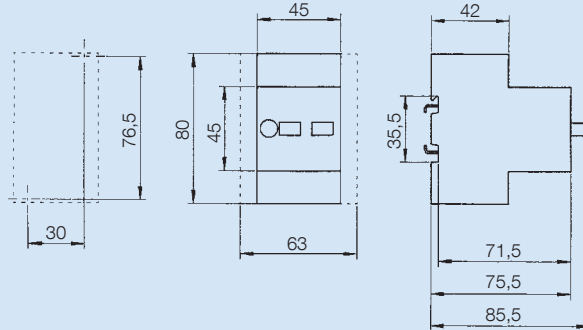

### Insulated enclosure MS.G55

possible to integrate 1 MPCB  
and 2 side mounted auxiliary  
contacts

Mounting dimensions

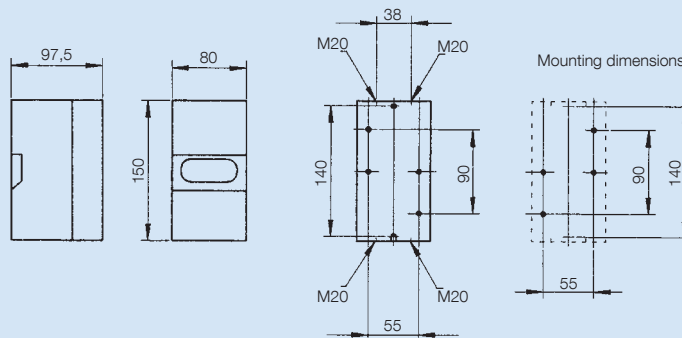

### Insulated flush mounting enclosure MS.F55

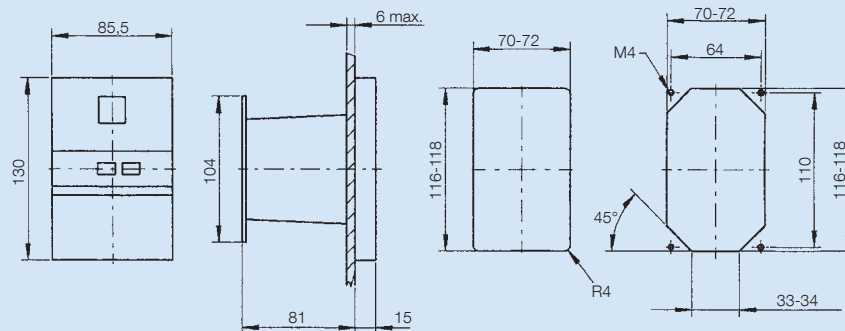

### Emergency-stop button MS.PT – PS.PS2

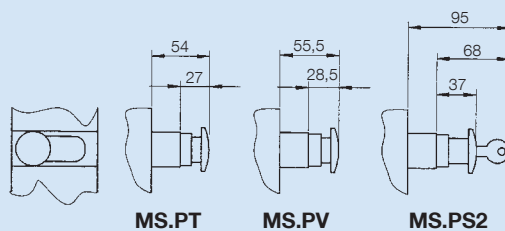

Horsepower rating and Kilowatt rating	
Horsepower [hp]	Kilowatt [kW]
0.167	0.13
0.25	0.184
0.5	0.38
0.75	0.55
1	0.735
1.25	0.919
1.5	1.103
1.75	1.287
2	1.471
2.5	1.839
3	2.206
4	2.942
5	3.677
6	4.413
7	5.148
7.5	5.516
8	5.884
9	6.619
10	7.355
11	8.09
12	8.826
13	9.561
14	10.297
15	11.032
16	11.768

Wire cross section in AWG and mm <sup>2</sup>		
AWG No.	Cross section [mm <sup>2</sup> ]	Diameter [mm]
21	0.412	0.724
20	0.519	0.813
19	0.653	0.912
18	0.824	1.27
17	1.01	1.151
16	1.307	1.29
15	1.651	1.45
14	2.082	1.628
13	2.627	1.829
12	3.307	2.052
11	4.169	2.304
10	5.26	2.588
9	6.633	2.906
8	8.367	3.264
7	10.55	3.665
6	13.229	4.115
5	16.767	4.62
4	21.148	5.189
3	26.667	5.827
2	33.624	6.543
1	42.406	7.348
1/0	53.182	8.252
2/0	67.43	9.266
3/0	85.014	10.404
4/0	107.22	11.684





---

## **ABL SURSUM Switching Devices according to UL1077 and CSA-22.2 No. 235**



**Our range of UL1077 supplementary protectors can be used where any additional protection in control circuits is required, and – combined with the accessories from our UL508 UM range – it also offers enhanced monitoring and control capabilities.**

# Switching Devices Supplementary Protector

according to UL1077 and CSA-22.2 No.235  
UR Product Range, B, C and D Characteristics

  
File E 137915



Rated current $I_n$ A	B Article no.	Characteristic C Article no.	D Article no.	Weight g/each	Packing unit
--------------------------	------------------	------------------------------------	------------------	------------------	-----------------

1-pole					
0.5		1C05UR	1D05UR	150	12
1	1B1UR	1C1UR	1D1UR	150	12
2	1B2UR	1C2UR	1D2UR	150	12
3	1B3UR	1C3UR	1D3UR	150	12
4	1B4UR	1C4UR	1D4UR	150	12
5	1B5UR	1C5UR	1D5UR	150	12
6	1B6UR	1C6UR	1D6UR	150	12
8	1B8UR	1C8UR	1D8UR	150	12
10	1B10UR	1C10UR	1D10UR	150	12
12	1B12UR	1C12UR	1D12UR	150	12
13	1B13UR	1C13UR	1D13UR	150	12
15	1B15UR	1C15UR	1D15UR	150	12
16	1B16UR	1C16UR	1D16UR	150	12
20	1B20UR	1C20UR	1D20UR	150	12
25	1B25UR	1C25UR	1D25UR	150	12
30	1B30UR	1C30UR	1D30UR	150	12
32	1B32UR	1C32UR	1D32UR	150	12
40	1B40UR	1C40UR	1D40UR	150	12
50	1B50UR	1C50UR	1D50UR	150	12
60	1B60UR	1C60UR	1D60UR	150	12
63 *	1B63UR	1C63UR	1D63UR	150	12

\* 63 A without UL approval



2-pole					
0.5		2C05UR	2D05UR	300	6
1	2B1UR	2C1UR	2D1UR	300	6
2		2C2UR	2D2UR	300	6
3	2B3UR	2C3UR	2D3UR	300	6
4	2B4UR	2C4UR	2D4UR	300	6
5	2B5UR	2C5UR	2D5UR	300	6
6	2B6UR	2C6UR	2D6UR	300	6
8	2B8UR	2C8UR	2D8UR	300	6
10	2B10UR	2C10UR	2D10UR	300	6
12	2B12UR	2C12UR	2D12UR	300	6
13	2B13UR	2C13UR	2D13UR	300	6
15	2B15UR	2C15UR	2D15UR	300	6
16	2B16UR	2C16UR	2D16UR	300	6
20	2B20UR	2C20UR	2D20UR	300	6
25	2B25UR	2C25UR	2D25UR	300	6
30	2B30UR	2C30UR	2D30UR	300	6
32	2B32UR	2C32UR	2D32UR	300	6
40	2B40UR	2C40UR	2D40UR	300	6
50	2B50UR	2C50UR	2D50UR	300	6
60	2B60UR	2C60UR	2D60UR	300	6
63 *	2B63UR	2C63UR	2D63UR	300	6

\* 63 A without UL approval

# Switching Devices Supplementary Protector

according to UL1077 and CSA-22.2 No.235  
UR Product Range, B, C and D Characteristics



Rated current $I_n$ A	B Article no.	Characteristic C Article no.	D Article no.	Weight g/each	Packing unit
--------------------------	------------------	---------------------------------	------------------	------------------	-----------------

3-pole					
0.5		3C05UR	3D05UR	450	4
1	3B1UR	3C1UR	3D1UR	450	4
2	3B2UR	3C2UR	3D2UR	450	4
3	3B3UR	3C3UR	3D3UR	450	4
4	3B4UR	3C4UR	3D4UR	450	4
5	3B5UR	3C5UR	3D5UR	450	4
6	3B6UR	3C6UR	3D6UR	450	4
8	3B8UR	3C8UR	3D8UR	450	4
10	3B10UR	3C10UR	3D10UR	450	4
12	3B12UR	3C12UR	3D12UR	450	4
13	3B13UR	3C13UR	3D13UR	450	4
15	3B15UR	3C15UR	3D15UR	450	4
16	3B16UR	3C16UR	3D16UR	450	4
20	3B20UR	3C20UR	3D20UR	450	4
25	3B25UR	3C25UR	3D25UR	450	4
30	3B30UR	3C30UR	3D30UR	450	4
32	3B32UR	3C32UR	3D32UR	450	4
40	3B40UR	3C40UR	3D40UR	450	4
50	3B50UR	3C50UR	3D50UR	450	4
60	3B60UR	3C60UR	3D60UR	450	4
63 *	3B63UR	3C63UR	3D63UR	450	4

\* 63 A without UL approval



Rated current $I_n$ A	Rated voltage Volt AC	Test currents * electromagnetic		Article no.	Weight g/each	Packing unit
		not tripping $I_4$ A	tripping $I_5$ A			

Neutral switch – for mounting instructions please consult page 75						
0.3 - 63	277/480	400	700	N63UM	150	5

\* additional electromagnetic protection

according to UL508 and CSA-22.2 No.14  
for Product Ranges UM and UR



Auxiliary contact					
Module	Type of contact	Contacts	Article no.	Weight g/each	Packing unit
1/2	1 auxiliary contact	1NO	<b>H10UM</b>	35	10
1/2	2 auxiliary contacts	1NO + 1NC	<b>H11UM</b>	40	10
1/2	3 auxiliary contacts	1NO + 2NC	<b>H12UM</b>	45	10
1/2	3 auxiliary contacts	2NO + 1NC	<b>H21UM</b>	45	10

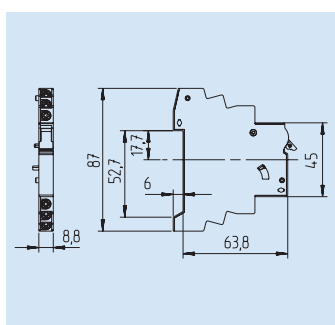

Standards	Acc. to IEC 60947-5-1, DIN EN 60947-5-1, VDE 0660-200, UL508	
Rated operating currents	10 A / 240 V AC 3 A / 110 V DC 1 A / 220 V DC	
Minimum contact load	1 mA at 24 V DC	
Conductor cross sections		
Type of conductor *)	min.	max.
Single wire	1.0 mm <sup>2</sup> (AWG18)	2.5 mm <sup>2</sup> (AWG14)
Stranded wire	1.0 mm <sup>2</sup> (AWG18)	1.5 mm <sup>2</sup> (AWG16)
Stranded wire with ferrule	1.0 mm <sup>2</sup> (AWG18)	1.5 mm <sup>2</sup> (AWG16)
Torque	max. 0.8 Nm (7 lb.in)	

\*) Stripped length 8 - 9 mm



Shunt trip					
Module	Rated operating voltage	max. operating current at U <sub>n</sub> (t < 10 ms)	Article no.	Weight g/each	Packing unit
1	12 V UC	1.3 A	<b>FA12UM</b>	105	5
1	24 V UC	0.6 A	<b>FA24UM</b>	105	5
1	48 - 74 V UC	0.2 A	<b>FA48UM</b>	105	5
1	110 - 240 V UC, 415 V AC	0.25 A at 110 V 0.5 A at 240 V 0.58 A at 277 V	<b>FA110UM</b>	105	5



Lock-off/Lock-on device		
Article no.	Weight g/each	Packing unit
<b>EASS</b>	2	10

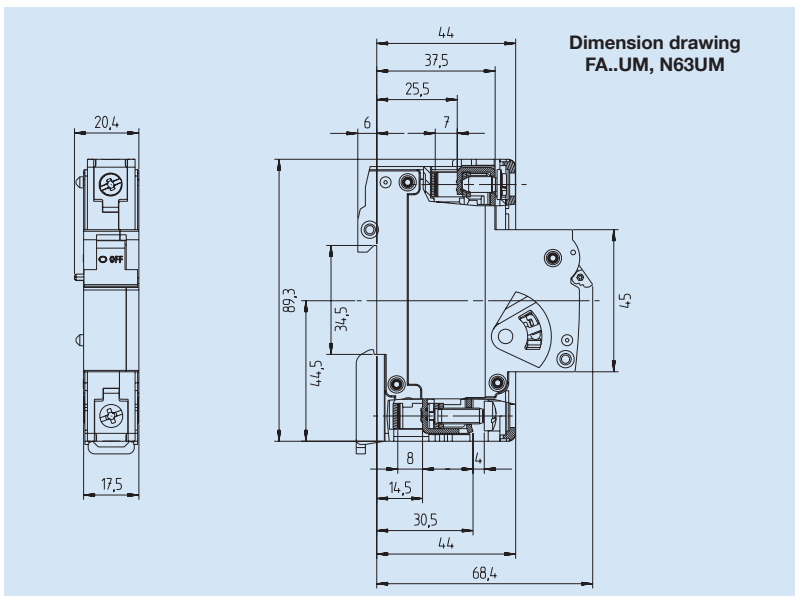

## Mounting Instructions of Accessories

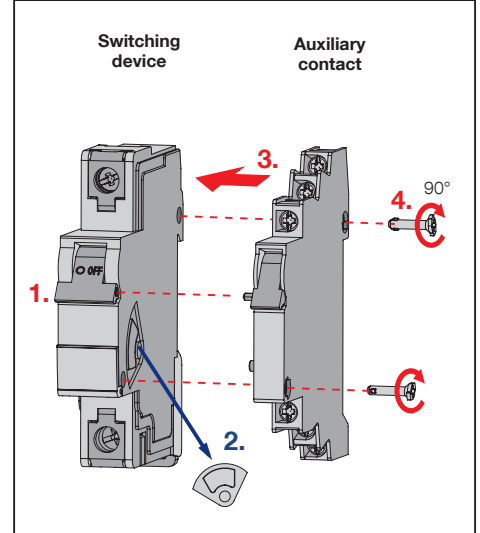
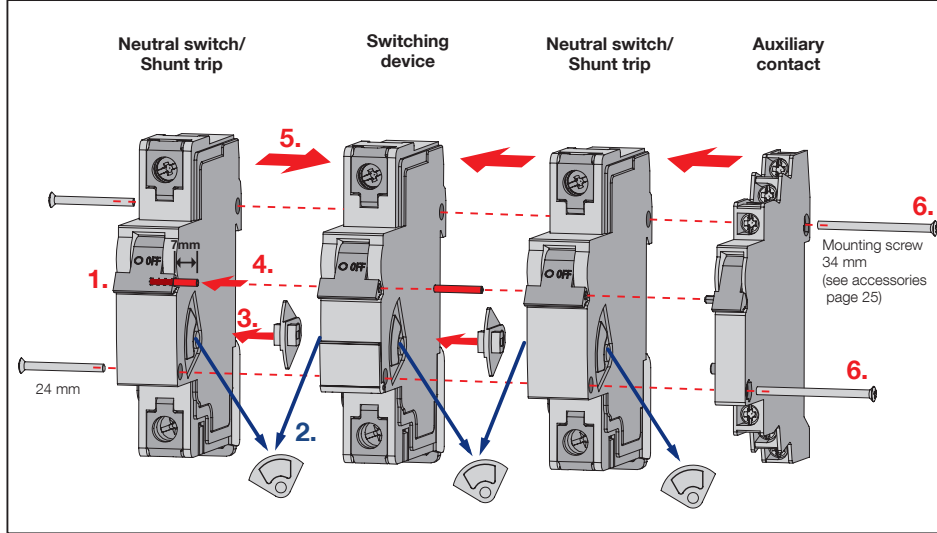

**Applies to N...UM and FA...UM:**  
The accessory devices N...UM and FA...UM can be mounted **on the right or left**.  
The auxiliary contact H...UM can only be mounted **on the right**.

**Mounting:**  
1. Bring the blue knobs of all devices into the "OFF" position  
2. Remove grey cover from the switching device and attachment  
3. Insert drive plate between the switching device and N...UM or FA...UM  
4. Insert connecting pin into the knob (insertion depth approx. 7 mm)  
5. Combine switching device and N...UM or FA...UM  
6. Screw devices together (observe correct screw length)

**Applies to H...UM:**  
The auxiliary contact H...UM can only be mounted **on the right**.

**Mounting:**  
1. Bring the blue knobs of both devices into the "OFF" position  
2. Remove grey cover from the switching device  
3. Combine switching device and H...UM  
4. Insert connection screws and connect the two devices by turning the screws by 90°  
5. After mounting close and open to check operation

**Applies to all switching devices ...UM, ...UR, N63UM and FA...UM**



Box terminal for  
• solid conductors  
• flexible conductors  
with or without cable lug



Screw terminal  
for forked cable lug



Screw terminal  
for ring cable lug  
(ring tongue)

### Design of the terminals

- Optical detection of the screw position
- Increased break resistance if the screwdriver becomes jammed
- Universal connecting terminals, suitable for connecting all known cable lugs such as ring or forked cable lugs and pin terminals

- Ring cable lugs can be connected by opening the flap and removing the connecting screw
- Can also be used for applications that require ring cable lugs (e.g. nuclear power stations)

- Protection against contact with live parts according to DIN EN 50274, VDE 0660-514 is fully guaranteed



# Switching Devices Supplementary Protector

according to UL1077 and CSA-22.2 No.235  
Product Range UR, B, C and D Characteristics  
Technical Data

Characteristic		B	C	D
Application		Lighting, Control circuits General electronics Wiring protection, Business equipment, Appliances	Lighting, Control circuits Wiring protection, Business equipment Appliances	Control transformers Power supplies Reactive load
Number of poles		1 - 3; 1 + N; 3 + N		
Standards		UL1077 and CSA-22.2 No.235		
Short circuit withstand rating		see data sheet for use in the USA and Canada (page 77)		
Current limiting class		3	3	
Max. back-up fuse		see data sheet for use in the USA and Canada (page 77)		
Rated voltage AC		277 / 480 V		
Rated current range		1 - 63* A	0.5 - 63* A	0.5 - 63* A
Test currents	Thermal not tripping $I_1 (A) > 1 \text{ h}$	$1.13 \times I_n$	$1.13 \times I_n$	$1.13 \times I_n$
	Thermal tripping $I_2 (A) < 1 \text{ h}$	$1.45 \times I_n$	$1.45 \times I_n$	$1.45 \times I_n$
	Electromagnetic not tripping $I_4 (A) > 0,1 \text{ s}$	$3 \times I_n$	$5 \times I_n$	$10 \times I_n$
	Electromagnetic tripping $I_5 (A) < 0,1 \text{ s}$	$5 \times I_n$	$10 \times I_n$	$16 \times I_n$
Reference calibration temperature of the thermal tripping		30° C + 5° C  Influence of the ambient temperature on the thermal release: Decrease of the current values with higher ambient temperature and increase with lower temperatures of approximately 5% per 10°C difference in temperature		
Frequency range of the electromagnetic trip		16 <sup>2</sup> / <sub>3</sub> to 60 Hz With higher frequencies, the electromagnetic tripping values increase by approximately a factor of 1.1 at 100 Hz; 1.2 at 200 Hz; 1.3 at 300 Hz; 1.4 at 400 Hz; 1.5 for DC		
Ambient temperature		-25 °C to +55 °C		
Storage temperature		-40 °C to +70 °C		
Device depth according to DIN 43880		68 mm		
Mechanical life		10,000 cycles (ON / OFF)		
Protection cover		Finger safe and safe to back of hand according to DIN EN 50274/ VDE0660-514, BGV A3		
Insulation group acc. to DIN/VDE 0110		C at 250 V AC B at 400 V AC		
Degree of protection acc. to EN/IEC 60529		IP20		
Installation position		any		
Mounting		DIN-rail according to DIN EN 60715 35 mm		
Lockability		The handle can be secured against manual switching in the on and off position by a lead seal		
Climatic resistance		Humid heat constant according to DIN EN 60068-2-78 Humid heat cycle according to DIN EN 60068-2-30		
Vibration resistance		> 15 g according to DIN EN 60068-2-59 during a load with $I_1$		
Resistance to mechanical shocks		25g 11ms		

\* 63 A without UL approval

# Switching Devices Supplementary Protector

according to UL1077 and CSA-22.2 No.235  
Product Range UR, B, C and D Characteristics  
Technical Data

Type of conductor *)	Conductor cross sections			
	Box terminal bottom		Box terminal top	
	max.	min.	max.	min.
Single wire	35 mm <sup>2</sup> (AWG2)	1 mm <sup>2</sup> (AWG18)	25 mm <sup>2</sup> (AWG3)	1 mm <sup>2</sup> (AWG18)
Multiple wire	35 mm <sup>2</sup> (AWG2)	16 mm <sup>2</sup> (AWG6)	25 mm <sup>2</sup> (AWG3)	16 mm <sup>2</sup> (AWG6)
Stranded wire	25 mm <sup>2</sup> (AWG3)	1 mm <sup>2</sup> (AWG18)	16 mm <sup>2</sup> (AWG6)	1 mm <sup>2</sup> (AWG18)
Stranded wire with ferrule	16 mm <sup>2</sup> (AWG6)	1 mm <sup>2</sup> (AWG18)	16 mm <sup>2</sup> (AWG6)	1 mm <sup>2</sup> (AWG18)
Busbar cable lug	up to 3 mm thickness		up to 1.5 mm thickness	
Torque	max. 2.5 Nm (22.2 lb.in)			

\*) Stripped length: bottom 12 - 14 mm, top 10 - 12 mm

Short circuit withstand rating and maximum back-up fuse for use in the USA and Canada					
Characteristic	B, C and D				
	UL1077 and CSA-22.2 No.235				
Standards	Number of poles	Maximum rated voltage [V]	Rated current [A]	Short circuit withstand rating [kA]	Maximum back-up fuse [A]
Short circuit withstand rating at rated voltage Ambient temperature 40 °C	1 / 1 + N	277	0.3 - 10	10	70 A
	1 / 1 + N	277	12 - 60	10	4 x I <sub>n</sub>
	2 / 3 / 3 + N	480	0.3 - 10	10	70 A
	2 / 3 / 3 + N	480	12 - 60	10	4 x I <sub>n</sub>

Internal resistance for Product Ranges UR			
Rated current [A]	Trip characteristic		
	B [Ohm]	C [Ohm]	D [Ohm]
0.5		6.8540	6.0009
1,0	1.7000	1.7000	1.7560
2,0	0.4190	0.4190	0.4190
3,0	0.2020	0.2020	0.2020
4,0	0.1090	0.1090	0.1090
5,0	0.0654	0.0654	0.0654
6,0	0.0528	0.0528	0.0491
8,0	0.0278	0.0278	0.0240
10	0.0216	0.0216	0.0187
12/13	0.0113	0.0084	0.0085
15/16	0.0085	0.0085	0.0076
20	0.0067	0.0067	0.0064
25	0.0050	0.0050	0.0041
30/32	0.0032	0.0032	0.0027
40	0.0025	0.0025	0.0022
50	0.0019	0.0019	0.0018
60/63 *	0.0018	0.0018	0.0017

\* 63 A without UL approval

# Switching Devices Supplementary Protector

according to UL1077 and CSA-22.2 No.235  
Product Range UR, B, C and D Characteristics  
Technical Data

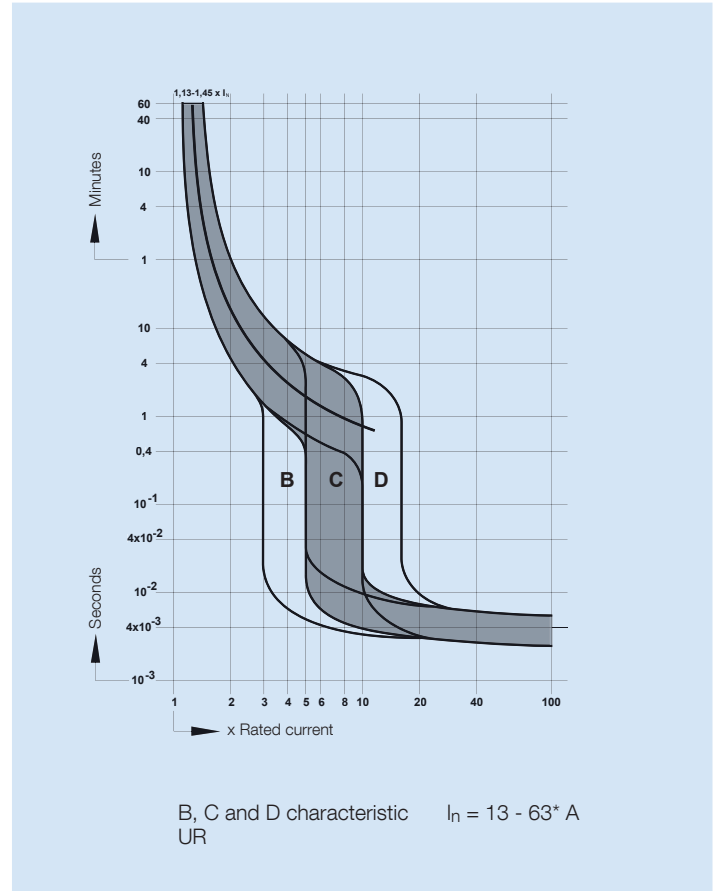
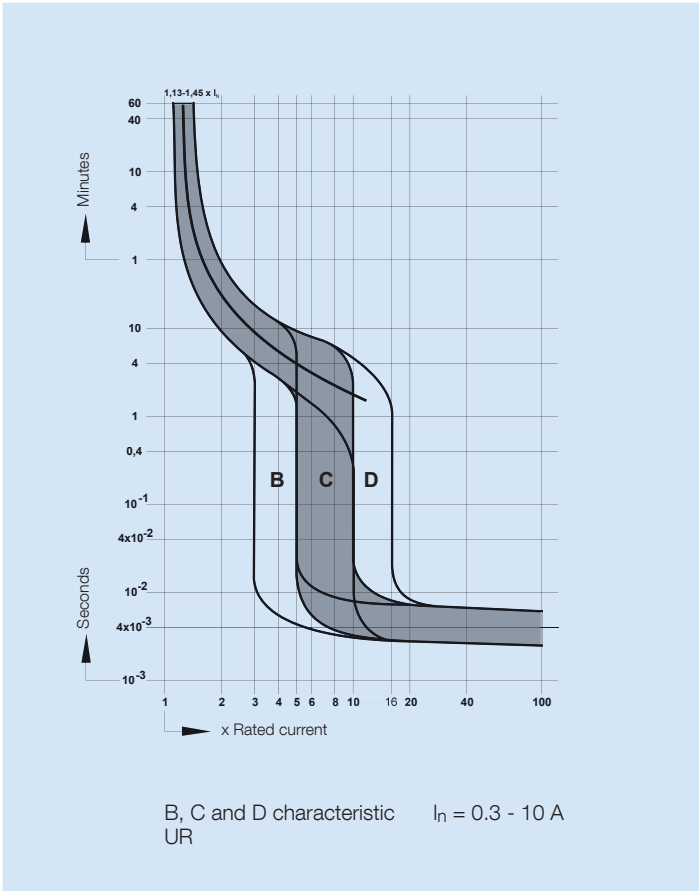

\* 63 A without UL approval

# Switching Devices Supplementary Protector

according to UL1077 and CSA-22.2 No.235  
Product Range UR, B, C and D Characteristics  
Dimension Drawing

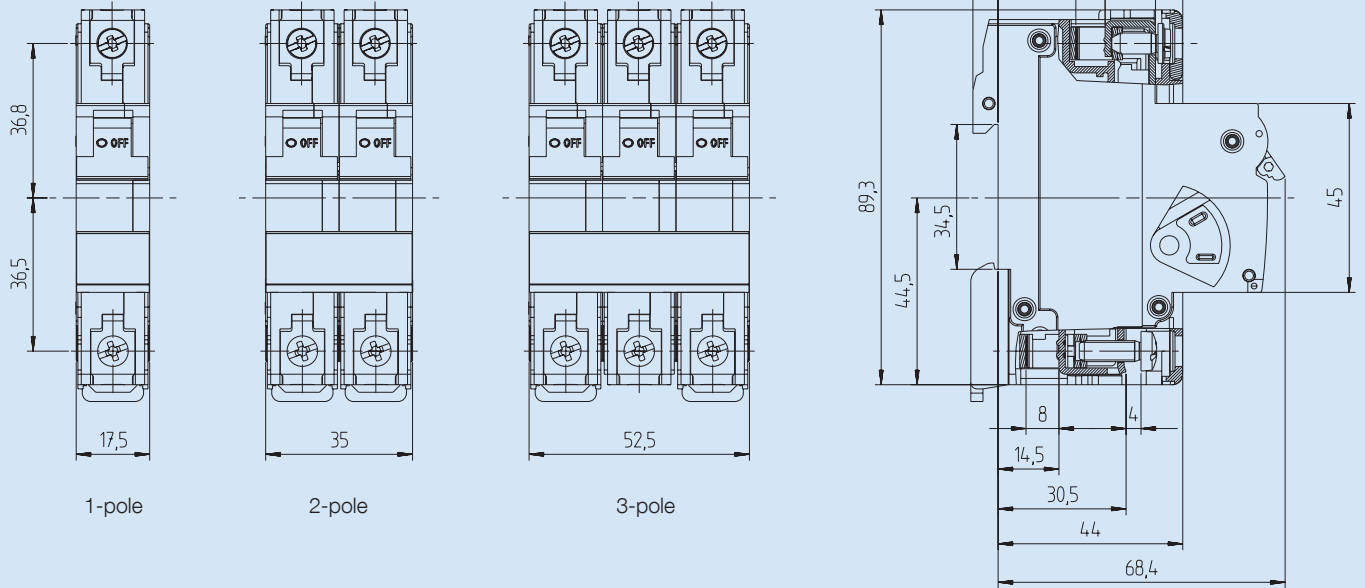

Setting market standards with new developments has always been a fundamental concern for ABL SURSUM. Such is the idea behind the SCHUKO system, to this day one of the most popular plug connection systems in the world and the creation of ABL founder Albert Büttner.

The first screw-in circuit breaker with an electromagnetic release was created at SURSUM, founded in 1912 by Wilhelm Leyhausen. These two inventions were the prelude to a series of innovative developments which have given the two companies a central role in the annals of consumer electronics for decades.

In 1986 the two traditional medium-sized companies merged; plug connection specialist ABL and circuit breaker specialist SURSUM formed one highly productive company now known as ABL SURSUM Bayerische Elektrozubehör GmbH & Co.KG.





# Product Range Connection Systems

## SCHUKO plug connections

Naturally, the inventor of the SCHUKO system has a large selection of SCHUKO plug connections in its product range. This range of products is actually so extensive that even experts are constantly surprised!



SCHUKO plugs and connectors, socket outlets, international plug connections, infeed plugs, outlet boxes, supply connections for boats and caravans, Perilex plug connections and Industrial Ethernet connections can be found in our catalogue "Connection Technology".

Detailed information can be found at:  
[www.abl-sursum.com](http://www.abl-sursum.com)



Regardless of whether you need building installation, industrial installation, switchgear manufacturing or cable pre-assembly: Whatever you need, you can be sure that you will find the right solution in our extensive range of approx. 7,000 products.

If you need a specific solution, let us know – our experts will find it!

### Miniature circuit breakers

Even today, ABL SURSUM is continuously developing new innovative market-driven products to ensure constant development of installation technology.

We meet the daily installation demands for ever more effectiveness and speed with our screwless clamping technology “plug2power”, to be found in our **miniature circuit breakers, our distribution boards, CEE plug connections, socket outlets and outlet boxes.**

Our new generation of miniature circuit breakers, with their completely new design and technology, are divided into the three product ranges S, SL and T, and allow us to offer you numerous advantages in terms of functionality, compatibility, and quality. This has created an ideal complete system for the wide-ranging installation requirements for both craftsmen and industry. These products are so attractive because of the low height, clear design, clearly legible labels and the new mounting system, which allows for removing from a busbar combination - below (“singlefix”) with the S and SL series and both above and below with the T series (“twinfix”).



### RCCBs, RCBOs

ABL SURSUM offers an extensive range of RCCBs to provide protection from dangerous shock currents or as fire-protection measures.

Regardless of whether you need a short-time delayed switch-off e.g. for the operation of suppressor capacitors or need a selective switch-off, whether it needs to be sensitive to pulsating current or universal current, you will find what you need in our range. Combined RCBOs offer the possibility of implementing these person and line protection measures in one device.



# Product range

## Switching devices



### DIN rail panel products

Off and toggle switches, 1 or multiple poles, with or without light signals, buttons, SCHUKO sockets for DIN-rails, installation/storage/control and time relays, mechanical impulse switches, touch dimmers, network activators, installation contactors, staircase lighting timers, time switches and transformers – our range of DIN rail panel products is as varied as the requirements of modern domestic installation.

MADE IN  
GERMANY



### Distribution boards

And to make sure that these DIN rail panel products can be installed in a proper manner and more importantly as specified, we of course also supply distribution boards in different sizes and versions.



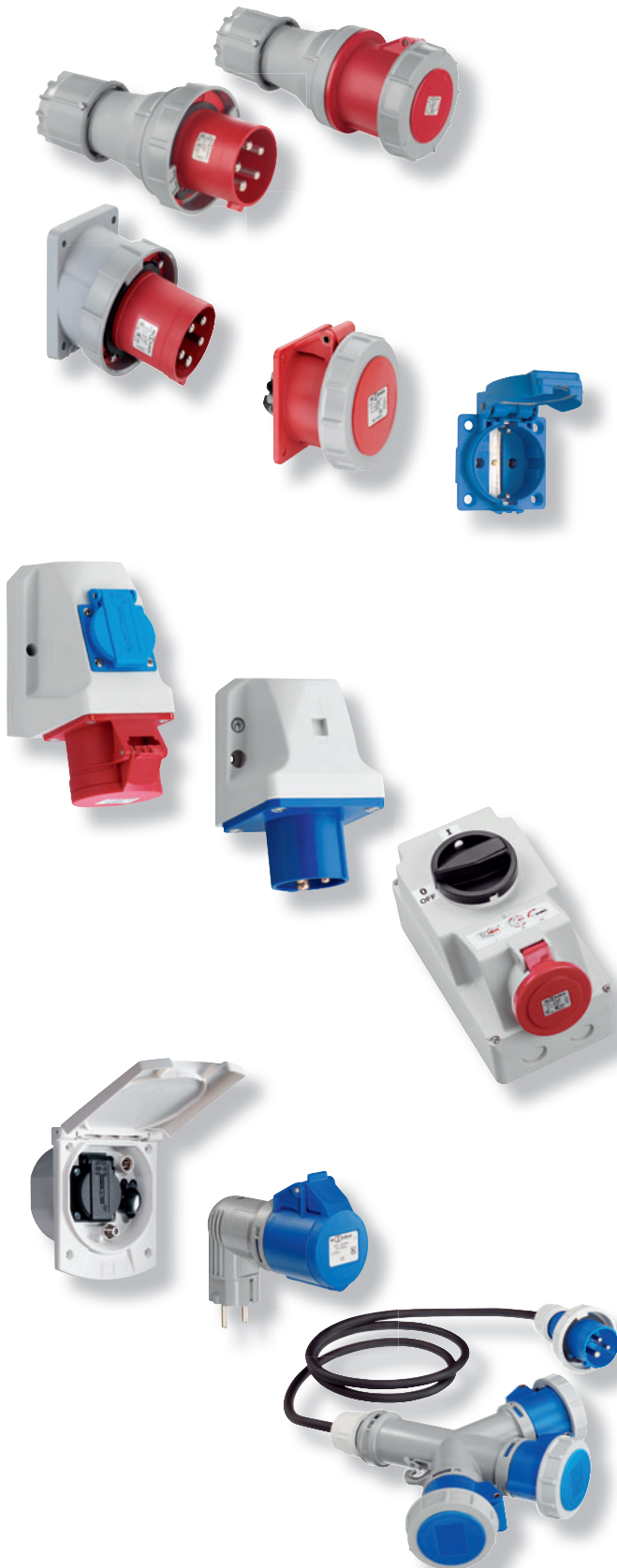

**Plugs and sockets**

We provide the best CEE connections: for plugs and connectors, appliance/ wall-mounted/ flanged socket outlets, input plugs, inverter plugs, container/ extra-low voltage/ boat and caravan plug connections, on adapters or multiple plugs...

CEE plugs and sockets by ABL SURSUM can do more than just transfer electricity. They support everyday work effectively and reliably, because they withstand the toughest conditions. It doesn't matter whether they are subjected to cold or heat, dust and water or pressure, strain and impact in the most diverse requirements in extreme working conditions.

You can rely on our products – in every situation, no matter where.

**Products for every application.  
An incredibly large diversity of  
models awaits you in our catalogue  
“Industrial Plugs and Sockets”.**



## Product Range Socket Outlet Combinations



### Socket outlet combinations, socket outlet cases, free-standing distribution units and power cubes

Large variation for a large variety of different uses is what sets this extensive ABL SURSUM product range apart.

Almost unlimited combination possibilities with CEE and SCHUKO socket outlets in the degrees of protection IP44 and IP67, as well as the protection provided by high performance RCCBs and miniature circuit breakers, can be manufactured for almost every individual need.

And with the sockets available in many different country versions, our combinations are also very well suited for international use. These combinations from ABL SURSUM are available in different versions: stationary, mobile and for suspension. The housings are made of high-quality thermoplastics in different qualities or from solid rubber and combine excellent mechanical, thermal and electric characteristics.

Individual solutions for every application.  
An incredibly large diversity of models  
awaits you in our catalogue  
"Socket Outlet Combinations".





Article no.	Page	Article no.	Page	Article no.	Page
1B1.6UM	35	1C12DL	22	1C50UR	72
1B10UM	35	1C12UL	20	1C5DL	22
1B10UR	72	1C12UR	72	1C5UL	20
1B12UR	72	1C13DL	22	1C5UM	35
1B13UM	35	1C13UL	20	1C5UR	72
1B13UR	72	1C13UM	35	1C60DL	22
1B15UM	35	1C13UR	72	1C60UL	20
1B15UR	72	1C15DL	22	1C60UM	35
1B16UM	35	1C15UL	20	1C60UR	72
1B16UR	72	1C15UM	35	1C63DL	22
1B1UM	35	1C15UR	72	1C63UL	20
1B1UR	72	1C16DL	22	1C63UM	35
1B2.5UM	35	1C16UL	20	1C63UR	72
1B20UM	35	1C16UM	35	1C6DL	22
1B20UR	72	1C16UR	72	1C6UL	20
1B25UM	35	1C1DL	22	1C6UM	35
1B25UR	72	1C1UL	20	1C6UR	72
1B2UM	35	1C1UM	35	1C8DL	22
1B2UR	72	1C1UR	72	1C8UL	20
1B3.5UM	35	1C2.5UM	35	1C8UM	35
1B30UM	35	1C20DL	22	1C8UR	72
1B30UR	72	1C20UL	20	1D03UL	20
1B32UM	35	1C20UM	35	1D03UM	35
1B32UR	72	1C20UR	72	1D05UL	20
1B3UM	35	1C25DL	22	1D05UM	35
1B3UR	72	1C25UL	20	1D05UR	72
1B40UM	35	1C25UM	35	1D075UM	35
1B40UR	72	1C25UR	72	1D1.6UL	20
1B4UM	35	1C2DL	22	1D1.6UM	35
1B4UR	72	1C2UL	20	1D10UL	20
1B50UM	35	1C2UM	35	1D10UM	35
1B50UR	72	1C2UR	72	1D10UR	72
1B5UM	35	1C3.5UM	35	1D12UL	20
1B5UR	72	1C30DL	22	1D12UR	72
1B60UM	35	1C30UL	20	1D13UL	20
1B60UR	72	1C30UM	35	1D13UM	35
1B63UM	35	1C30UR	72	1D13UR	72
1B63UR	72	1C32DL	22	1D15UL	20
1B6UM	35	1C32UL	20	1D15UM	35
1B6UR	72	1C32UM	35	1D15UR	72
1B8UR	72	1C32UR	72	1D16UL	20
1C03DL	22	1C3DL	22	1D16UM	35
1C03UL	20	1C3UL	20	1D16UR	72
1C03UM	35	1C3UM	35	1D1UI	20
1C05DL	22	1C3UR	72	1D1UM	35
1C05UL	20	1C40DL	22	1D1UR	72
1C05UM	35	1C40UL	20	1D2.5UM	35
1C05UR	72	1C40UM	35	1D20UL	20
1C075UM	35	1C40UR	72	1D20UM	35
1C1.6DL	22	1C4DL	22	1D20UR	72
1C1.6UL	20	1C4UL	20	1D25UL	20
1C1.6UM	35	1C4UM	35	1D25UM	35
1C10DL	22	1C4UR	72	1D25UR	72
1C10UL	20	1C50DL	22	1D2UL	20
1C10UM	35	1C50UL	20	1D2UM	35
1C10UR	72	1C50UM	35	1D2UR	72

## Article Number Directory

Article no.	Page	Article no.	Page	Article no.	Page	Article no.	Page
1D3.5UM	35	1E63UM	35	2B13UM	36	2C15UL	20
1D30UL	20	1E6UM	35	2B13UR	72	2C15UM	36
1D30UM	35	1E8UM	35	2B15UM	36	2C15UR	72
1D30UR	72	1G03UM	35	2B15UR	72	2C16DL	22
1D32UL	20	1G05UM	35	2B16UM	36	2C16UL	20
1D32UM	35	1G08UM	35	2B16UR	72	2C16UM	36
1D32UR	72	1G1.6UM	35	2B1UM	36	2C16UR	72
1D3UL	20	1G10UM	35	2B1UR	72	2C1DL	22
1D3UM	35	1G12UM	35	2B20UM	36	2C1UL	20
1D3UR	72	1G13UM	35	2B20UR	72	2C1UM	36
1D40UL	20	1G15UM	35	2B25UM	36	2C1UR	72
1D40UM	35	1G16UM	35	2B25UR	72	2C2.5UM	36
1D40UR	72	1G1UM	35	2B30UM	36	2C20DL	22
1D4UL	20	1G2.5UM	35	2B30UR	72	2C20UL	20
1D4UM	35	1G20UM	35	2B32UM	36	2C20UM	36
1D4UR	72	1G25UM	35	2B32UR	72	2C20UR	72
1D50UL	20	1G2UM	35	2B3UM	36	2C25DL	22
1D50UM	35	1G3.5UM	35	2B3UR	72	2C25UL	20
1D50UR	72	1G30UM	35	2B40UM	36	2C25UM	36
1D5UL	20	1G32UM	35	2B40UR	72	2C25UR	72
1D5UM	35	1G3UM	35	2B4UM	36	2C2DL	22
1D5UR	72	1G40UM	35	2B4UR	72	2C2UL	20
1D60UL	20	1G4UM	35	2B50UM	36	2C2UM	36
1D60UM	35	1G50UM	35	2B50UR	72	2C2UR	72
1D60UR	72	1G5UM	35	2B5UM	36	2C3.5UM	36
1D63UL	20	1G60UM	35	2B5UR	72	2C30DL	22
1D63UM	35	1G63UM	35	2B60UM	36	2C30UL	20
1D63UR	72	1G6UM	35	2B60UR	72	2C30UM	36
1D6UL	20	1G8UM	35	2B63UM	36	2C30UR	72
1D6UM	35	1Z03UM	35	2B63UR	72	2C32DL	22
1D6UR	72	1Z05UM	35	2B6UM	36	2C32UL	20
1D8UL	20	1Z075UM	35	2B6UR	72	2C32UM	36
1D8UM	35	1Z1.6UM	35	2B8UR	72	2C32UR	72
1D8UR	72	1Z10UM	35	2C03DL	22	2C3DL	22
1E03UM	35	1Z12UM	35	2C03UL	20	2C3UL	20
1E05UM	35	1Z13UM	35	2C03UM	36	2C3UM	36
1E075UM	35	1Z15UM	35	2C05DL	22	2C3UR	72
1E1.6UM	35	1Z16UM	35	2C05UL	20	2C40DL	22
1E10UM	35	1Z1UM	35	2C05UM	36	2C40UL	20
1E13UM	35	1Z2.5UM	35	2C05UR	72	2C40UM	36
1E15UM	35	1Z20UM	35	2C075UM	36	2C40UR	72
1E16UM	35	1Z25UM	35	2C1.6DL	22	2C4DL	22
1E1UM	35	1Z2UM	35	2C1.6UL	20	2C4UL	20
1E2.5UM	35	1Z3.5UM	35	2C1.6UM	36	2C4UM	36
1E20UM	35	1Z30UM	35	2C10DL	22	2C4UR	72
1E25UM	35	1Z32UM	35	2C10UL	20	2C50DL	22
1E2UM	35	1Z3UM	35	2C10UM	36	2C50UL	20
1E3.5UM	35	1Z40UM	35	2C10UR	72	2C50UM	36
1E30UM	35	1Z4UM	35	2C12DL	22	2C50UR	72
1E32UM	35	1Z50UM	35	2C12UL	20	2C5DL	22
1E3UM	35	1Z5UM	35	2C12UR	72	2C5UL	20
1E40UM	35	1Z6UM	35	2C13DL	22	2C5UM	36
1E4UM	35	1Z8UM	35	2C13UL	20	2C5UR	72
1E50UM	35	2B10UM	36	2C13UM	36	2C60DL	22
1E5UM	35	2B10UR	72	2C13UR	72	2C60UL	20
1E60UM	35	2B12UR	72	2C15DL	22	2C60UM	36

Article no.	Page	Article no.	Page	Article no.	Page	Article no.	Page
2C60UR	72	2D3UM	36	2G12UM	36	3B1UR	73
2C63DL	22	2D3UR	72	2G13UM	36	3B2.5UM	37
2C63UL	20	2D40UL	20	2G15UM	36	3B20UM	37
2C63UM	36	2D40UM	36	2G16UM	36	3B20UR	73
2C63UR	72	2D40UR	72	2G1UM	36	3B25UM	37
2C6DL	22	2D4UL	20	2G2.5UM	36	3B25UR	73
2C6UL	20	2D4UM	36	2G20UM	36	3B2UM	37
2C6UM	36	2D4UR	72	2G25UM	36	3B2UR	73
2C6UR	72	2D50UL	20	2G2UM	36	3B3.5UM	37
2C8DL	22	2D50UM	36	2G3.5UM	36	3B30UM	37
2C8UL	20	2D50UR	72	2G30UM	36	3B30UR	73
2C8UM	36	2D5UL	20	2G32UM	36	3B32UM	37
2C8UR	72	2D5UM	36	2G3UM	36	3B32UR	73
2D03UL	20	2D5UR	72	2G40UM	36	3B3UM	37
2D03UM	36	2D60UL	20	2G4UM	36	3B3UR	73
2D05UL	20	2D60UM	36	2G50UM	36	3B40UM	37
2D05UM	36	2D60UR	72	2G5UM	36	3B40UR	73
2D05UR	72	2D63UL	20	2G60UM	36	3B4UM	37
2D075UM	36	2D63UM	36	2G63UM	36	3B4UR	73
2D1.6UL	20	2D63UR	72	2G6UM	36	3B50UM	37
2D1.6UM	36	2D6UL	20	2G8UM	36	3B50UR	73
2D10UL	20	2D6UM	36	2Z03UM	36	3B5UM	37
2D10UM	36	2D6UR	72	2Z05UM	36	3B5UR	73
2D10UR	72	2D8UL	20	2Z075UM	36	3B60UM	37
2D12UL	20	2D8UM	36	2Z1.6UM	36	3B60UR	73
2D12UR	72	2D8UR	72	2Z10UM	36	3B63UM	37
2D13UL	20	2E03UM	36	2Z12UM	36	3B63UR	73
2D13UM	36	2E05UM	36	2Z13UM	36	3B6UM	37
2D13UR	72	2E075UM	36	2Z15UM	36	3B6UR	73
2D15UL	20	2E1.6UM	36	2Z16UM	36	3B8UR	73
2D15UM	36	2E10UM	36	2Z1UM	36	3C03UL	21
2D15UR	72	2E13UM	36	2Z2.5UM	36	3C03UM	37
2D16UL	20	2E15UM	36	2Z20UM	36	3C05UL	21
2D16UM	36	2E16UM	36	2Z25UM	36	3C05UM	37
2D16UR	72	2E1UM	36	2Z2UM	36	3C05UR	73
2D1UI	20	2E2.5UM	36	2Z3.5UM	36	3C075UM	37
2D1UM	36	2E20UM	36	2Z30UM	36	3C1.6UL	21
2D1UR	72	2E25UM	36	2Z32UM	36	3C1.6UM	37
2D2.5UM	36	2E2UM	36	2Z3UM	36	3C10UL	21
2D20UL	20	2E3.5UM	36	2Z40UM	36	3C10UM	37
2D20UM	36	2E30UM	36	2Z4UM	36	3C10UR	73
2D20UR	72	2E32UM	36	2Z50UM	36	3C12UL	21
2D25UL	20	2E3UM	36	2Z5UM	36	3C12UR	73
2D25UM	36	2E40UM	36	2Z6UM	36	3C13UL	21
2D25UR	72	2E4UM	36	2Z8UM	36	3C13UM	37
2D2UL	20	2E50UM	36	3B1.6UM	37	3C13UR	73
2D2UM	36	2E5UM	36	3B10UM	37	3C15UL	21
2D2UR	72	2E60UM	36	3B10UR	73	3C15UM	37
2D3.5UM	36	2E63UM	36	3B12UR	73	3C15UR	73
2D30UL	20	2E6UM	36	3B13UM	37	3C16UL	21
2D30UM	36	2E8UM	36	3B13UR	73	3C16UM	37
2D30UR	72	2G03UM	36	3B15UM	37	3C16UR	73
2D32UL	20	2G05UM	36	3B15UR	73	3C1UL	21
2D32UM	36	2G08UM	36	3B16UM	37	3C1UM	37
2D32UR	72	2G1.6UM	36	3B16UR	73	3C1UR	73
2D3UL	20	2G10UM	36	3B1UM	37	3C2.5UM	37

Article no.	Page	Article no.	Page	Article no.	Page	Article no.	Page
3C20UL	21	3D13UL	21	3E03UM	37	3Z12UM	37
3C20UM	37	3D13UM	37	3E05UM	37	3Z13UM	37
3C20UR	73	3D13UR	73	3E075UM	37	3Z15UM	37
3C25UL	21	3D15UL	21	3E1.6UM	37	3Z16UM	37
3C25UM	37	3D15UM	37	3E10UM	37	3Z1UM	37
3C25UR	73	3D15UR	73	3E13UM	37	3Z2.5UM	37
3C2UL	21	3D16UL	21	3E15UM	37	3Z20UM	37
3C2UM	37	3D16UM	37	3E16UM	37	3Z25UM	37
3C2UR	73	3D16UR	73	3E1UM	37	3Z2UM	37
3C3.5UM	37	3D1UI	21	3E2.5UM	37	3Z3.5UM	37
3C30UL	21	3D1UM	37	3E20UM	37	3Z30UM	37
3C30UM	37	3D1UR	73	3E25UM	37	3Z32UM	37
3C30UR	73	3D2.5UM	37	3E2UM	37	3Z3UM	37
3C32UL	21	3D20UL	21	3E3.5UM	37	3Z40UM	37
3C32UM	37	3D20UM	37	3E30UM	37	3Z4UM	37
3C32UR	73	3D20UR	73	3E32UM	37	3Z50UM	37
3C3UL	21	3D25UL	21	3E3UM	37	3Z5UM	37
3C3UM	37	3D25UM	37	3E40UM	37	3Z6UM	37
3C3UR	73	3D25UR	73	3E4UM	37	3Z8UM	37
3C40UL	21	3D2UL	21	3E50UM	37	AK.U1	40
3C40UM	37	3D2UM	37	3E5UM	37	AK35U	25
3C40UR	73	3D2UR	73	3E60UM	37	AMS110	63
3C4UL	21	3D3.5UM	37	3E63UM	37	AMS220	63
3C4UM	37	3D30UL	21	3E6UM	37	AMS24	63
3C4UR	73	3D30UM	37	3E8UM	37	AMS380	63
3C50UL	21	3D30UR	73	3G03UM	37	AMS500	63
3C50UM	37	3D32UL	21	3G05UM	37	AMSD24	63
3C50UR	73	3D32UM	37	3G08UM	37	BS.UL	25
3C5UL	21	3D32UR	73	3G1.6UM	37	E983419	25
3C5UM	37	3D3UL	21	3G10UM	37	EASS	24
3C5UR	73	3D3UM	37	3G12UM	37	EASS	38
3C60UL	21	3D3UR	73	3G13UM	37	EASS	55
3C60UM	37	3D40UL	21	3G15UM	37	EASS	74
3C60UR	73	3D40UM	37	3G16UM	37	FA110UL	24
3C63UL	21	3D40UR	73	3G1UM	37	FA110UM	38
3C63UM	37	3D4UL	21	3G2.5UM	37	FA110UM	74
3C63UR	73	3D4UM	37	3G20UM	37	FA110UM	54
3C6UL	21	3D4UR	73	3G25UM	37	FA12UL	24
3C6UM	37	3D50UL	21	3G2UM	37	FA12UM	38
3C6UR	73	3D50UM	37	3G3.5UM	37	FA12UM	74
3C8UL	21	3D50UR	73	3G30UM	37	FA12UM	54
3C8UM	37	3D5UL	21	3G32UM	37	FA24UL	24
3C8UR	73	3D5UM	37	3G3UM	37	FA24UM	38
3D03UL	21	3D5UR	73	3G40UM	37	FA24UM	74
3D03UM	37	3D60UL	21	3G4UM	37	FA24UM	54
3D05UL	21	3D60UM	37	3G50UM	37	FA48UL	24
3D05UM	37	3D60UR	73	3G5UM	37	FA48UM	38
3D05UR	73	3D63UL	21	3G60UM	37	FA48UM	54
3D075UM	37	3D63UM	37	3G63UM	37	FA48UM	74
3D1.6UL	21	3D63UR	73	3G6UM	37	H10UL	24
3D1.6UM	37	3D6UL	21	3G8UM	37	H10UM	38
3D10UL	21	3D6UM	37	3Z03UM	37	H10UM	54
3D10UM	37	3D6UR	73	3Z05UM	37	H10UM	74
3D10UR	73	3D8UL	21	3Z075UM	37	H11UL	24
3D12UL	21	3D8UM	37	3Z1.6UM	37	H11UM	38
3D12UR	73	3D8UR	73	3Z10UM	37	H11UM	54

Article no.	Page	Article no.	Page
H11UM	74	MS6.3	61
H12UL	24	N32UL	21
H12UM	38	N63UL	21
H12UM	74	N63UM	37
H12UM	54	N63UM	73
H21UL	24	S106U	25
H21UM	38	S112U	25
H21UM	74	S206U	25
H21UM	54	S216U	25
HDS	55	S306U	25
HMS01	62	S316U	25
HMS02	62	S3BRU	25
HMS10	62	SB.D02	65
HMS11	62	SB.D03	65
HMS20	62	SB.D04	65
MA016UM	53	SB.D12	65
MA025UM	53	SB.D13	65
MA040UM	53	SB.D14	65
MA063UM	53	SB.D15	65
MA1.0UM	53	SB.D22	65
MA1.6UM	53	SB.D24	65
MA10UM	53	SB.DA1	65
MA16UM	53	SB.DE1	65
MA2.5UM	53	SB.U1	40
MA20UM	53	SB.U1H	40
MA25UM	53	SB.U3	40
MA32UM	53	SB.U3H	40
MA4.0UM	53	SB.U9	40
MA40UM	53	SB16010	41
MA6.3UM	53	SB26010	41
MS.F55	64	SB26216	41
MS.G55	64	SB31210	41
MS.PS2	64	SB36010	41
MS.PT	64	SB36016	41
MS.PV	64	SB36316	41
MS.SLG2	64	SB46016	41
MS.SLG3	64	SB718U	41
MS.SLJ2	64	SDO.124	41
MS.SLJ3	64	SDO.316	41
MS.SLR2	64	UA120UM	54
MS.SLR3	64	UA220UM	54
MS.SLW2	64	UMS110	63
MS.SLW3	64	UMS220	63
MS.VS	64	UMS24	63
MS016	61	UMS380	63
MS025	61	UMS500	63
MS040	61	VHMS11	62
MS063	61	VHMS20	62
MS1	61		
MS1.6	61		
MS10	61		
MS16	61		
MS2.5	61		
MS20	61		
MS25	61		
MS4	61		







**ABL SURSUM  
Bayerische Elektrozubehör  
GmbH & Co. KG**

Ottenssooser Strasse 22  
D-91207 Lauf / Pegnitz  
Germany

Postfach 10 02 47  
D-91192 Lauf / Pegnitz  
Germany

Telephone: +49 (0)9123 188-0  
Facsimile: +49 (0)9123 188-188

E-Mail: [info@abl-sursum.com](mailto:info@abl-sursum.com)  
Internet: [www.abl-sursum.com](http://www.abl-sursum.com)